

**XE SERIES  
PERSONAL COMPUTER  
FIELD SERVICE  
MANUAL**



**CREATED BY  
JER / EIGHTBITTER  
2014**

## TABLE OF CONTENTS

Section	Title	Page
	INTRODUCTION	IV
1	THEORY OF OPERATION	1-1
	User Interface	1-2
	Mechanical Description	1-3
	Digital Hardware	1-5
	6502 (Modified) CPU Microprocessor	1-5
	Alphanumeric Television Interface Controller (Antic Display Processor)	1-6
	Graphics Television Interface Adaptor (GTIA)	1-7
	POT Keyboard Integrated Circuit (POKEY)	1-8
	Peripheral Interface Adaptor (PIA)	1-9
	Memory (ROM and RAM)	1-11
	Memory Management Unit (MMU)	1-11
	RF Modulator	1-11
	Power Supply	1-11
	System Interface	1-11
	Serial Input/Output (SIO Interface)	1-12
	Keyboard Interface	1-13
	Controller Jack Interface	1-14
	Cartridge Interface	1-15
	Monitor Interface	1-16
2	SCHEMATICS AND PICTURES	2-1
3	TESTING	3-1
	Overview	3-1
	Equipment Needed	3-1
	Self Test	3-1
	MEMORY TEST Screen	3-2
	AUDIO VISUAL TEST Screen	3-2
	KEYBOARD TEST Screen	3-3
	ALL TESTS	3-3
	Using the ATARI REV. 3.2 Production Test Cartridge	3-3
	COLOR BAR TEST	3-6
	ANY VIDEO TEST	3-7
	GRAY BAR TEST	3-g
	DISPLAY OPTIONS	3-9
	RAM TEST	3-9

## TABLE OF CONTENTS (Cont.)

Section	Title	Page
4	SYMPTOM CHECKLIST	4-1
	Adjustments & Replacements	4-2
	Console Disassembly	4-2
	Console Assembly	4-2
	Keyboard Removal/Replacement	4-3
	Color Adjustment	4-3
5	SERVICE BULLETINS	5-1

## TABLE OF ILLUSTRATIONS

Figure	Title	Page
1-1	130XE Right Side Panel	1-1
1-2	130XE Back View	1-1
1-3	130XE Top View	1-2
1-4	130XE Functional Block Diagram	1-4
1-5	6502C CPU Pin Assignments	1-6
1-6	ANTIC Display Processor Pin Assignments	1-6
1-7	GTIA Pin Assignments	1-7
1-8	POKEY Pin Assignments	1-7
1-9	PIA Pin Assignments	1-8
1-10	Freddie Pin Assignments	1-8
1-11	External Power Supply Schematic	1-10
1-12	SIO Interface Pin Assignments	1-11
1-13	Controller Jack Interface Pin Assignments	1-11
1-14	Cartridge Slot Pin Assignments	1-12
1-15	Expansion Slot Pin Assignments	1-13
1-16	Monitor Jack Pin Assignments	1-13
2-1	Atari 130XE 16 X 4164 Assembly CO70065/CO70067	2-2
2-2	CO7065/CO70067 PCB	2-3
2-3	Atari 130XE SECAM CO70052 Rev. 2 PCB	2-4
2-4	Atari 130XE SECAM	2-5
2-5	Atari 130XE 4 X 4464 Assembly CA200519	2-6

2-4	CA200519 PCB	2-7
2-5	Atari 65XE 8 X 4164 Assembly CO70025	2-8
2-6	CO70025 PCB	2-9
2-7	Atari 65XE 8 X 4164 Assembly CA20097	2-10
2-8	CA20097 PCB	2-11
2-9	Atari 65XE/800XE 2 X 4464 Assemblies CA200519	2-12
2-10	65XE/800XE CA200519 PCB	2-13
2-11	XE-System Assembly C100417	2-14
2-12	C100417 PCB	2-15
2-13	XE Keyboard Matrix	2-16
2-14	PCB and Shield Assemblies	2-17
3-1	SELF TEST Menu	3-1
3-2	MEMORY Test display	3-2
3-3	AUDIO-VISUAL Test display	3-2
3-4	KEYBOARD Test display	3-3
3-5	Select Screen	3-4
3-6	Main Menu display	3-4
3-7	AUDIO Test display	3-5
3-8	VIDEO Test display	3-6
3-9	PORT Test display	3-7
3-10	KEYBOARD Test display	3-8
3-11	ROM Test display	3-8
3-12	RAM Test 65XE OK.	3-9
3-13	RAM Test Fail	3-9
3-14	Cartridge & Expansion Slot Test Fixture	3-10

## INTRODUCTION

The Atari 130XE Personal Computer Field Service Manual is a reference guide for the service technician. Since the XE series has more models, so on the basis of the 130XE model will also be discussed different versions 65XE computers, as well as console XE-SYSTEM .

This Field Service Manual is organized in six sections:

- **THEORY OF OPERATION** – Overview of how the 130XE works and what its basic assemblies look like.
- **SCHEMATICS AND SILKSCREENS** – Electrical drawings and layouts of the XE series printed circuit board.
- **TESTING** – Review of Diagnostic Tests available for diagnosing 130XE problems.
- **SYMPTOM CHECKLIST** – Failure information to assist the experienced technician arrive at a rapid diagnosis of XE series computers problems.
- **PARTS LIST** – Detailed breakdown of parts used in the XE computers.
- **SERVICE BULLETINS** – Section to be used to hold Field Change Orders, Upgrade Bulletins and Tech Tips.

## SECTION 1

### THEORY OF OPERATION

The Atari 130XE™ is an enhanced version of the existing Atari computer systems. It can be used with any existing Atari peripheral devices which are compatible with the 400™/800™ or XL series computer, although not all are necessary.

The console contains 128K of RAM and has an operating system which contains one 16k X 8 ROM. The console also contains the keyboard with a HELP key, four programmable function keys START, SELECT, OPTION, RESET, a single Cartridge slot, an Expansion connector, jacks for adding peripherals and hand controllers, a detachable (RF) TV interface cable and one power LED.

Use Figures 1-1, 1-2 and 1-3 as reference for the following discussion.

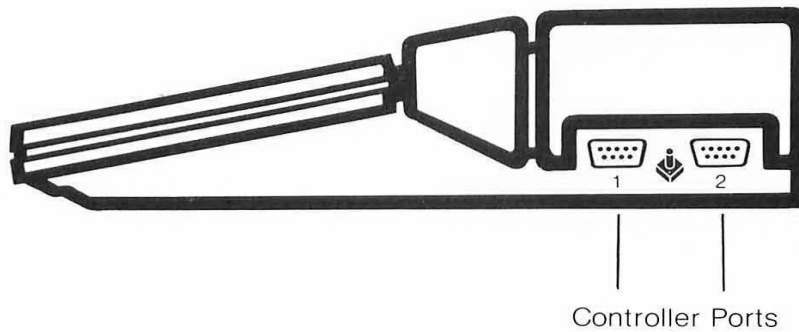

Figure 1-1. 130XE Right Side Panel

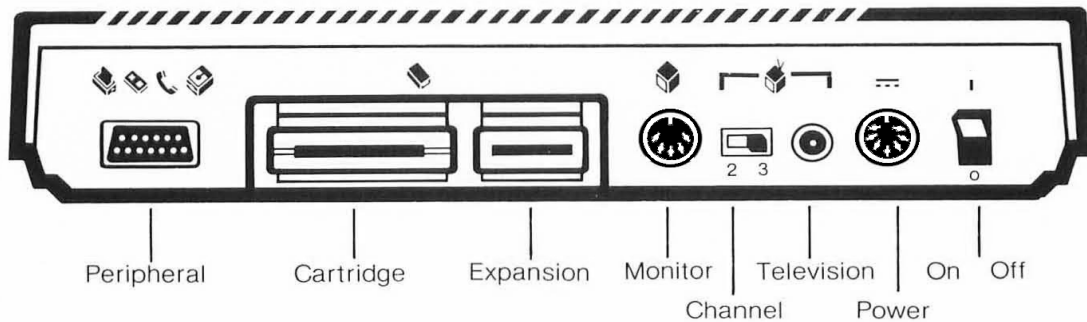

Figure 1-2. 130XE Back View.

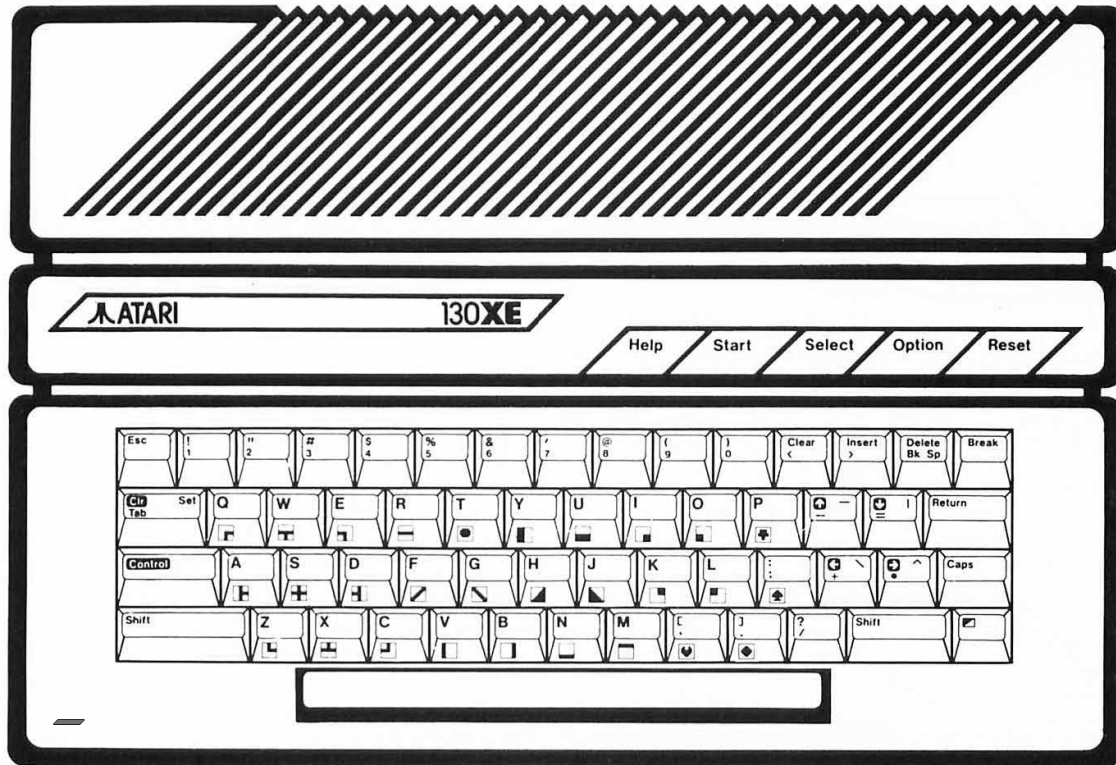

Figure 1-3. 130XE Top View

### User Interface

The Atari XE series are a general purpose microcomputers which uses a 6502C microprocessor. The 130XE console is the central processing unit for its respective system.

The right side panel (refer to Figure 1-1) contains two controller jacks. The controller jacks accept the X-Y joystick and the paddle controllers available from Atari.

The rear panel (refer to Figure 2-1) contains the Serial Input/Output (SIO) jack, Cartridge slot, the Expansion connector, the channel 2-3 switch, the RF cable jack, the Monitor jack, and the Power Jack.

The console has a full stroke 62 key alphanumeric keyboard, which includes special characters and controls, a space bar, and 5 function keys.

The 5 function keys above the keyboard are made of the same color material as cover. A translucent plexiglass strip on left-bottom corner of top cover indicate the operation (Power On) and covers the red LED.

From left to right the function keys are:

HELP – Gives you instruction in some programs when you need help.

START - Press to run loaded program. Frequently used to load program from cassette. Fully programmable key

SELECT – Often used to select one of several applications within a program. Fully programmable key.

OPTION – Allows the player to choose among the variations of a program. When this key is pressed during Power On – internal Basic is disconnected and – if you do not have active floppy drive – SELF TEST is running (see page 3-2). Fully programmable key.

RESET – Interrupts and restarts the operating system or cartridge.

#### Mechanical Description

The 130XE computer console contains a single motherboard which houses all the chips of the system and provides connectors for interfacing external modules to the console. It includes the CPU, ANTIC, GTIA, POKEY, PIA, FREDDIE, RAM, ROM Operating System, and includes all functions. The motherboard uses a common address bus, data bus and clock lines. The sixteen-line address bus allows the microprocessor to directly address 64K of memory locations. The eight-line data bus provides the communication and data path between the functional modules. The various power requirements are routed from the power supply throughout the console.

The keyboard is connected to the PC Board by a 24-conductor foil cable.

Figure 1-4 is a block diagram of the functional flow of the 130XE.



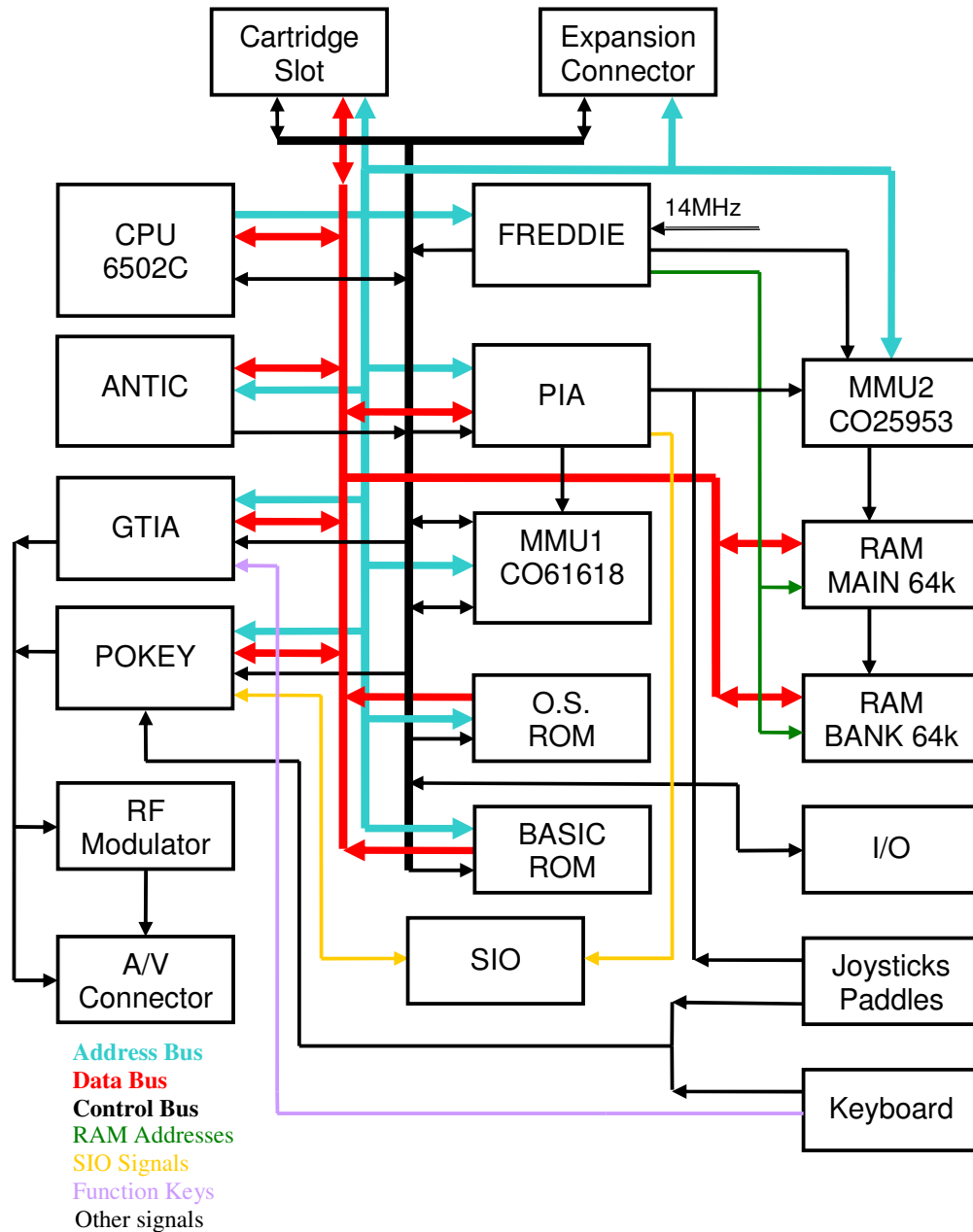

Figure 1-4. 130XE Functional Block Diagram.

## Digital Hardware

The digital hardware consists of:

- The 6502C CPU microprocessor
- The Alphanumeric Television Interface Controller (the ANTIC Display Processor)
- The Graphics Television Interface Adaptor (GTIA)
- The POT Keyboard Integrated Circuit (POKEY)
- The Peripheral Interface Adaptor (PIA)
- The Memory (ROM and RAM)
- Memory Management Units (MMU1 and MMU2)
- Clock and Memory Controller FREDDIE

### 6502C CPU Microprocessor

The 6502C (modified 6502) CPU microprocessor contains register flags, interconnections, arithmetic logic, control logic, and all recognized operation codes. The characteristics of the microprocessor are:

- Byte-oriented structure
- 151 opcodes
- Decimal and binary arithmetic modes Seven addressing modes
- True indexing Stack pointer
- Two interrupt levels 64K address range
- Integral clock circuit
- Single +5 volt DC power Requirement

Figure 1-4 is an illustration of the 6502C CPU Pin Assignments.

GROUND	1	VSS	RST	40	RESET
READY	2	RDY	O2	39	PHASE 2 CLOCK OUT
PHASE 1 CLOCK	3	O1	S0	38	S0
INTERRUPT REQUEST	4	IRQ	O0	37	PHASE 0 CLOCK IN
Not Connected	5	NC	R/W	36	READ/WRITE
NON MASK INTERRUPT	6	NMI	HALT	35	HALT
SYNC	7	SYNC	NC	34	Not Connected
+5V POWER	8	VCC	D0	33	DATA 0
BUS ADDRESS 0	9	A0	D1	32	DATA 1
BUS ADDRESS 1	10	A1	D2	31	DATA 2
BUS ADDRESS 2	11	A2	D3	30	DATA 3
BUS ADDRESS 3	12	A3	D4	29	DATA 4
BUS ADDRESS 4	13	A4	D5	28	DATA 5
BUS ADDRESS 5	14	A5	D6	27	DATA 6
BUS ADDRESS 6	15	A6	D7	26	DATA 7
BUS ADDRESS 7	16	A7	A15	25	BUS ADDRESS 15
BUS ADDRESS 8	17	A8	A14	24	BUS ADDRESS 14
BUS ADDRESS 9	18	A9	A13	23	BUS ADDRESS 13
BUS ADDRESS 10	19	A10	A12	22	BUS ADDRESS 12
BUS ADDRESS 11	20	A11	VSS	21	GROUND

6502C

Figure 1-5. 6502C CPU Pin Assignments.

### Alphanumeric Television Interface Controller (The ANTIC Display Processor

The ANTIC Display Processor is a custom display microprocessor with an instruction set customized for graphics generation. It also has the ability to control bus and RAM REFRESH.

GROUND	1	VSS	D4	40	DATA 4
GTIA DATA 0	2	ANO	D5	39	DATA 5
GTIA DATA 1	3	AN1	D6	38	DATA 6
LIGHT PEN	4	LP	D7	37	DATA 7
GTIA DATA 2	5	AN2	RST	36	RESET
Not Connected	6	RNMI	F00	35	FAST PHASE 0 CLOCK
INTERRUPT OUT	7	NMI	O0	34	PHASE 0 CLOCK
REFRESH	8	REF	D3	33	DATA 3
HALT	9	HALT	D2	32	DATA 2
BUS ADDRESS 3	10	A3	D1	31	DATA 1
BUS ADDRESS 2	11	A2	D0	30	DATA 0
BUS ADDRESS 1	12	A1	O2	29	PHASE 2 CLOCK
BUS ADDRESS 0	13	A0	A4	28	BUS ADDRESS 4
READ/WRITE	14	R/W	A5	27	BUS ADDRESS 5
READY	15	RDY	A6	26	BUS ADDRESS 6
BUS ADDRESS 10	16	A10	A7	25	BUS ADDRESS 7
BUS ADDRESS 12	17	A12	A8	24	BUS ADDRESS 8
BUS ADDRESS 13	18	A13	A9	23	BUS ADDRESS 9
BUS ADDRESS 14	19	A14	A11	22	BUS ADDRESS 11
BUS ADDRESS 15	20	A15	VCC	21	+5V POWER

ANTIC

Figure 1-6. Display Processor Pin Assignments

## Graphics Television Interface Adaptor (GTIA)

The GTIA interfaces with the ANTIC processor on one side and with the video summation circuitry on the other. Its primary task is to generate color and luminance signals from the display information bit stream it receives from the ANTIC Display Processor.

BUS ADDRESS 1	1	A1	A2	40	BUS ADDRESS 2
BUS ADDRESS 0	2	A0	A3	39	BUS ADDRESS 3
GROUND	3	VSS	A4	38	BUS ADDRESS 4
DATA 3	4	D3	D4	37	DATA 4
DATA 2	5	D2	D5	36	DATA 5
DATA 1	6	D1	D6	35	DATA 6
DATA 0	7	D0	D7	34	DATA 7
TRIGGER 0	8	T0	R/W	33	READ/WRITE
TRIGGER 1	9	T1	CS	32	CHIP SELECT
TRIGGER 2	10	T2	LUM0	31	LUMINANCE 0
TRIGGER 3	11	T3	O2	30	PHASE 2 INPUT
PORT SELECT 0	12	S0	F00	29	FAST PHASE 0 OUT
PORT SELECT 1	13	S1	OSC	28	OSCILLATOR IN
+CAV CONTROL	14	S2	VCC	27	+5V POWER
Not Used	15	S3	HALT	26	HALT
Not Connected	16	NC	CSYNC	25	SYNCHRO OUT
COLOR DELAY ADJ	17	CADJ	LUM3	24	LUMINANCE 3
ALPHANUM DATA 0	18	ANO	LUM2	23	LUMINANCE 2
ALPHANUM DATA 1	19	AN1	LUM1	22	LUMINANCE 1
ALPHANUM DATA 2	20	AN2	COLOR	21	COLOR

GTIA

Figure 1-7. GTIA pin assignments

## POT Keyboard Integrated Circuit (POKEY)

The POKEY is a Custom Large Scale Integrated Circuit (LSI) chip. It is used for audio generation, Serial Input/Output (SIO) control, controller interface scan and keyboard scan.

GROUND	1	VSS	D2	40	DATA 2
DATA 3	2	D3	D1	39	DATA 1
DATA 4	3	D4	D0	38	DATA 0
DATA 5	4	D5	AUDIO	37	AUDIO OUTPUT
DATA 6	5	D6	A0	36	BUS ADDRESS 0
DATA 7	6	D7	A1	35	BUS ADDRESS 1
PHASE 2 INPUT	7	O2	A2	34	BUS ADDRESS 2
POT SCAN 6	8	P6	A3	33	BUS ADDRESS 3
POT SCAN 7	9	P7	R/W	32	READ/WRITE CONTROL
POT SCAN 4	10	P4	CS1	31	CHIP SELECT 1
POT SCAN 5	11	P5	CS0	30	CHIP SELECT 0
POT SCAN 2	12	P2	IR	29	INTERRUPT REQUEST OUT
POT SCAN 3	13	P3	S0D	28	SERIAL OUTPUT DATA
POT SCAN 0	14	P0	ACLK	27	SERIAL OUTPUT CLOCK
POT SCAN 1	15	P1	BCLK	26	BIDIRECTIONAL CLOCK
SOFTFIRE	16	KR2	KR1	25	KEYBOARD READ
+5V POWER	17	VCC	SID	24	SERIAL INPUT DATA
Not Used	18	K5	K0	23	Not Used
KEYBOARD SCAN	19	K4	K1	22	KEYBOARD SCAN
KEYBOARD SCAN	20	K3	K2	21	KEYBOARD SCAN

POKEY

Figure 1-8. POKEY pin assignments

## Peripheral Interface Adaptor (PIA)

The PIA is a general purpose Input/Output (I/O) chip.

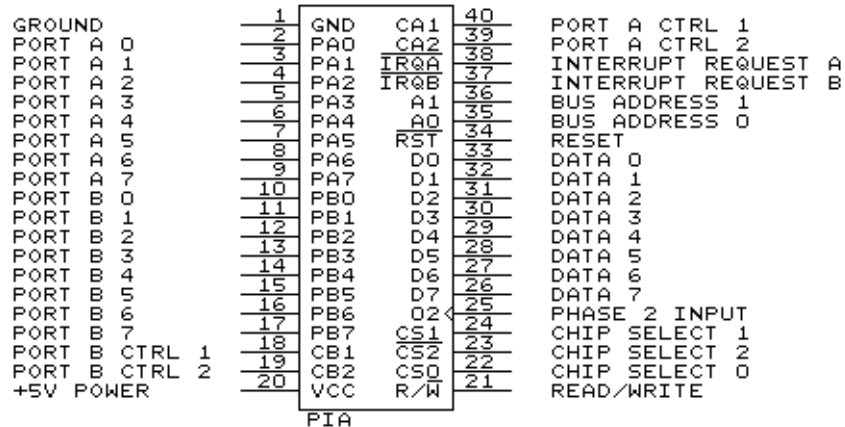

Figure 1-9. PIA pin assignments

## FREDDIE

Freddie is the controller of memory and generates a clock signal to CPU.

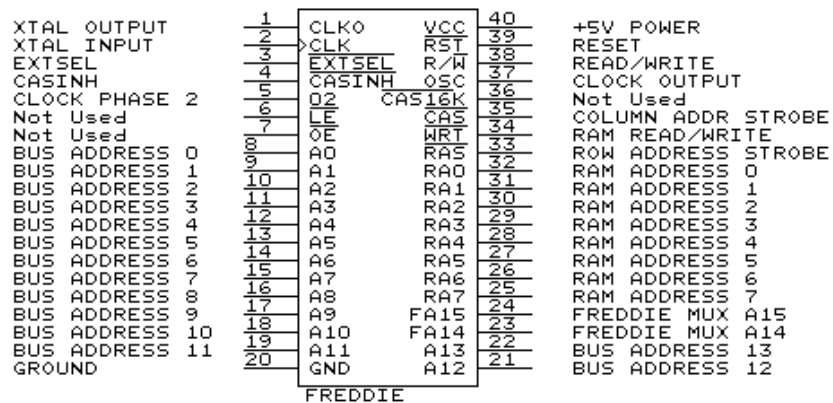

Figure 1-10. Freddie pin assignments

## Memory

The 130XE operating system is resident to 16k X 8 ROM. The ROM input CPU address lines A0 through A13 and the chip selects from the MMU, generates data on CPU data lines D0 through D7. RAM is organized as 16 X 64k x 1 or 4 X 64k X 4 chips, two for each data line. 48K RAM is directly available, but more is accessible under DOS 2.5.

## Memory Management Unit (MMU)

The Memory Management (Address Decoding) circuitry consists of a Programmable Array Logic (PAL) and one 3 to 8 decoder. The input to this circuitry are the address lines A8 thru A15 and control signals like ROM enable (from PIA) and Refresh. The outputs of this circuitry are GTIA chip select (D0XX), Expansion selects (D1XX), POKEY chip select (D2XX), PIA chip select (D3XX), Cartridge selects (D5XX), O.S. ROM selects and RAM selects.

## The RF Modulator

The RF Modulator inputs the composite video from the video summation circuitry and the monoaural audio signals and produces a modulated signal suitable for the television.

The modulated signal will have the following characteristics with a 75 $\Omega$  termination:

Maximum Voltage: 2 mV

Minimum Voltage: 1 mV

Audio Sound Carrier Frequency: 5.5 MHz

Frequency Response:

Ch. 3 61.25 MHz  $\pm$  0.5

Ch. 2 55.25 MHz

## Power Supply

The 130XE has a external power supply. The power supply jack, power on switch and filters are resident on the motherboard. The power supply accepts a 5V DC input through the power jack. An external step-down transformer accepts 115V AC or 230V AC from the power line and steps it down to 9VAC. The 9VAC input is rectified by a bridge rectifier and then regulated power output from the regulator.

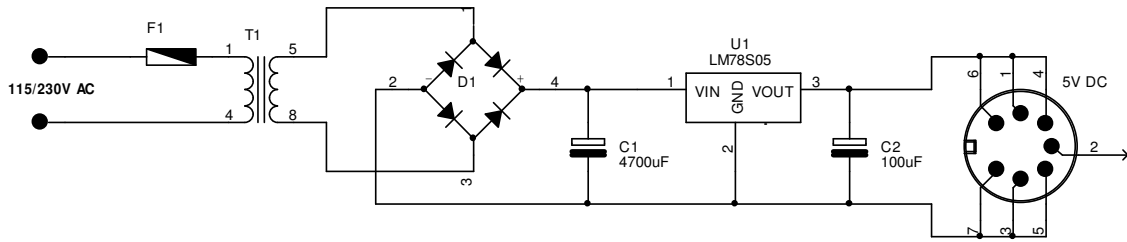

Figure 1-11. External Power Supply Schematic.

The DC output of regulator is 5V  $\pm$ 5% (1.5A Max).

### SYSTEM INTERFACE

The 130XE provides the following interfaces:

- The Serial Input/Output (SIO) interface
- The keyboard interface
- The controller jack interface
- The cartridge interface
- The monitor interface
- The LED board interface

### Serial Input/Output (SIO) Interface

The Atari 130XE communicates with peripheral devices over an asynchronous serial port (19.2K Baud Rate Max). Data is transmitted and received as 8 bits of serial data (LSB sent first) preceded by a logic zero start bit and succeeded by a logic one stop bit. The serial data out is transmitted as positive logic. The serial DATA OUT line always assumes its new state when the serial CLOCK OUT line goes high; CLOCK OUT goes low in the center of the DATA OUT time.

The bus protocol specifies that all commands must originate from the computer, and that peripherals present data on the bus only when commanded to do so. Every bus operation goes to completion before another bus operation is initiated (no overlap). An error detected at any point in the bus operation will abort the entire sequence. A bus operation consists of the following elements:

- Command Frame (From Computer)
- Acknowledge Frame (From Peripheral)
- Optional Data Frame (To or From Computer)
- Complete Frame (From Peripheral)

## Command Frame

The serial bus protocol provides for three types of commands:

- 1) Data Send
- 2) Data Receive
- 3) Immediate (No Data-Command Only)

PIN		PIN	
1	Clock In	7	Command
2	Clock Out	8	Motor Control
3	Data Into CPU	9	Proceed
4	GND	10	Ready (Computer ON)
5	Data Out	11	Audio In (175 mV)
6	GND	12	Not used
13	Interrupt		

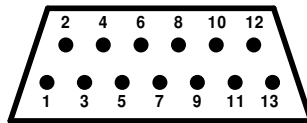

Figure 1-12. SIO Interface Pin Assignments (looking into jack on unit)  
External view

## Controller Jack Interface

The 130XE provides two controller jack interfaces. Both are functionally and electrically identical. The controller jacks are 9-pin D-type connectors.

- |                             |                  |
|-----------------------------|------------------|
| 1. (Joystick) Forward Input | 6. Trigger Input |
| 2. (Joystick) Back Input    | 7. +5 volts      |
| 3. (Joystick) Left Input    | 8. Ground        |
| 4. (Joystick) Right Input   | 9. Pot A Input   |
| 5. Pot B Input              |                  |

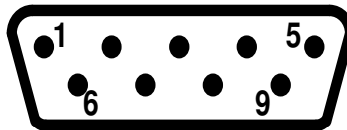

Figure 1-13. Controller Jack Pin Assignments (from right side of 130XE)  
External view



## Cartridge and Expansion Interface

The cartridge interface is a 30 pin edge connector, the expansion is 14 pin edge connector.

This side up



External view

Pin	Assignments	Pin	Assignments
A	RD4 Input from cartridge	1	!S4 Select
B	GND Ground	2	A3 Address Bus
C	A4 Address Bus	3	A2 Address Bus
D	A5 Address Bus	4	A1 Address Bus
E	A6 Address Bus	5	A0 Address Bus
F	A7 Address Bus	6	D4 Data Bus
H	A8 Address Bus	7	D5 Data Bus
J	A9 Address Bus	8	D2 Data Bus
K	A12 Address Bus	9	D1 Data Bus
L	D3 Data Bus	10	D0 Data Bus
M	D7 Data bus	11	D6 Data Bus
N	A11 Address Bus	12	!S5 Select
P	A10 Address Bus	13	Vcc +5V
R	R!/W Read/Write	14	RD5 Input from cartridge
S	BØ2 Buffered Phase 2	15	!CCTL Cartridge Enable

Figure 1-14. Cartridge Interface Pin Assignment  
(!) Signal active LOW



Pin	Assignments
A	N.C. Not Connected
B	!IRQ Interrupt Request
C	!HALT from Antic
D	A13 Address Bus
E	A14 Address Bus
F	A15 Address Bus
H	GND Ground

Pin	Assignments
1	!EXTSEL External Select
2	!RST Reset
3	!D1XX I/O page D1 Select
4	MPD from MMU
5	!AUDIO Audio Input
6	!REF Memory Refresh
7	Vcc +5V

Figure 1-15. Expansion Interface Pin Assignment

(!) Signal active LOW

### Monitor Jack

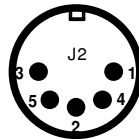

Figure 1-16. Monitor Jack Pin Assignment

Pin 1 Monochrome VideoOutput

Pin 2 GND Ground

Pin 3 Audio Output

Pin 4 Composite Video Output

Pin 5 Color Output

## SECTION 2

### SCHEMATICS AND PICTURES

The schematics and silkscreens for the 130XE, originally they were attached to the cover of this manual, but due to the poor condition of copies have been redesigned and presented in this chapter.

Minor variations in design may be encountered depending upon the production date of the console. Shown below drawings provide all details required for an in-depth understanding of the 130XE and her smaller sisters 65XE.

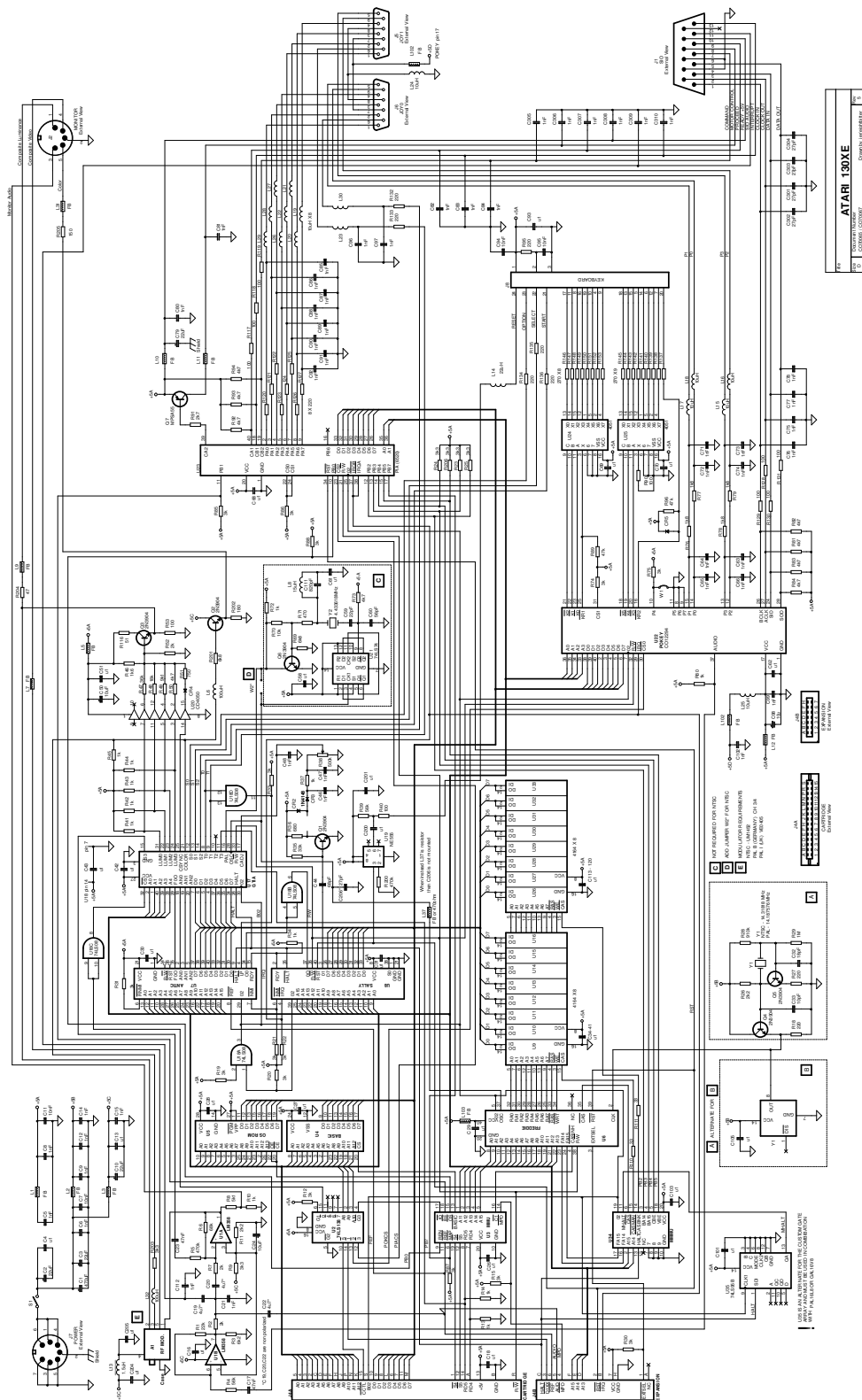

Figure 2-1. Schematic Atari 130XE 16 X 4164 Assembly CO70065/CO70067

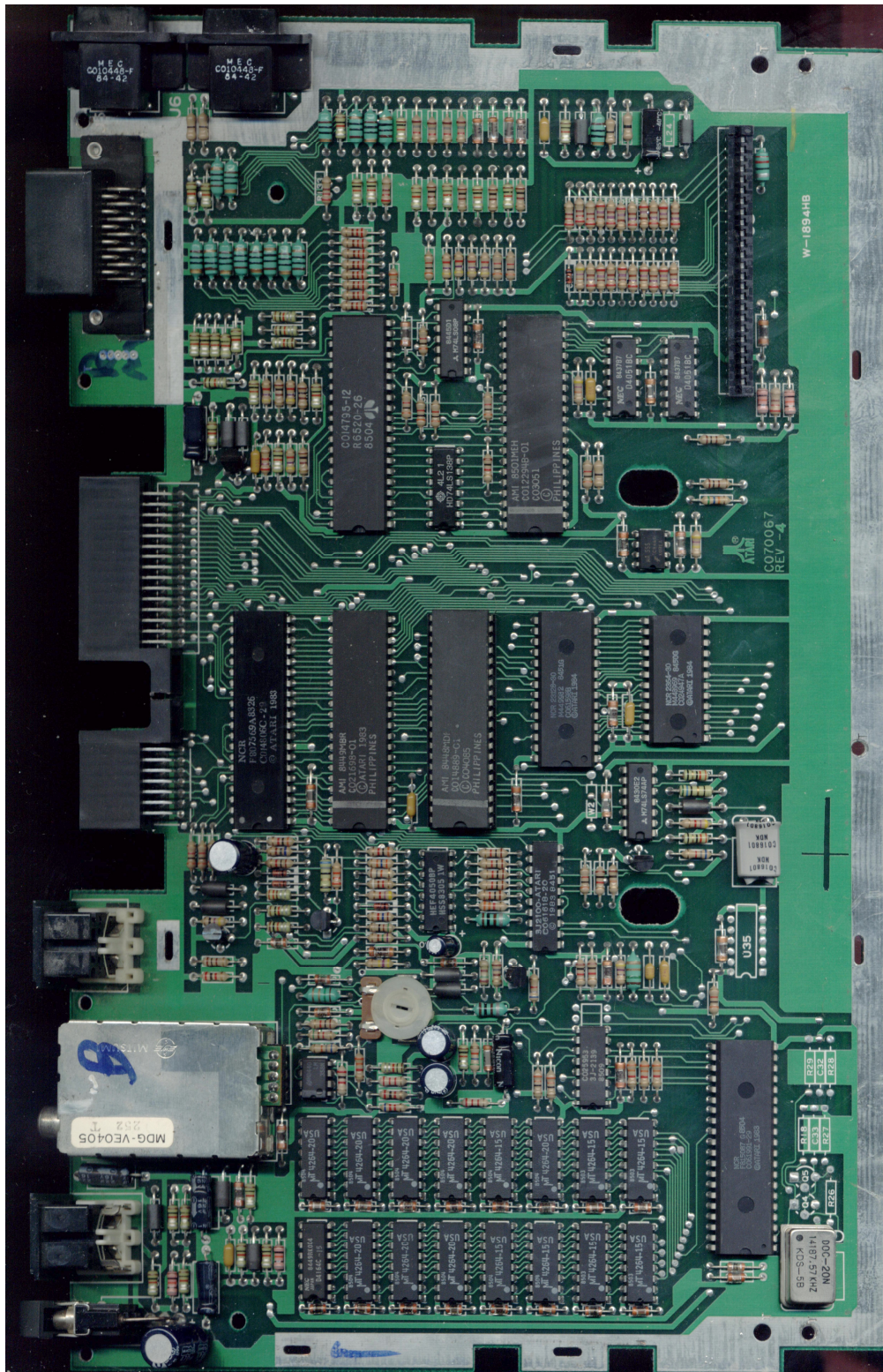

Figure 2-2. CO70065/CO70067 PCB

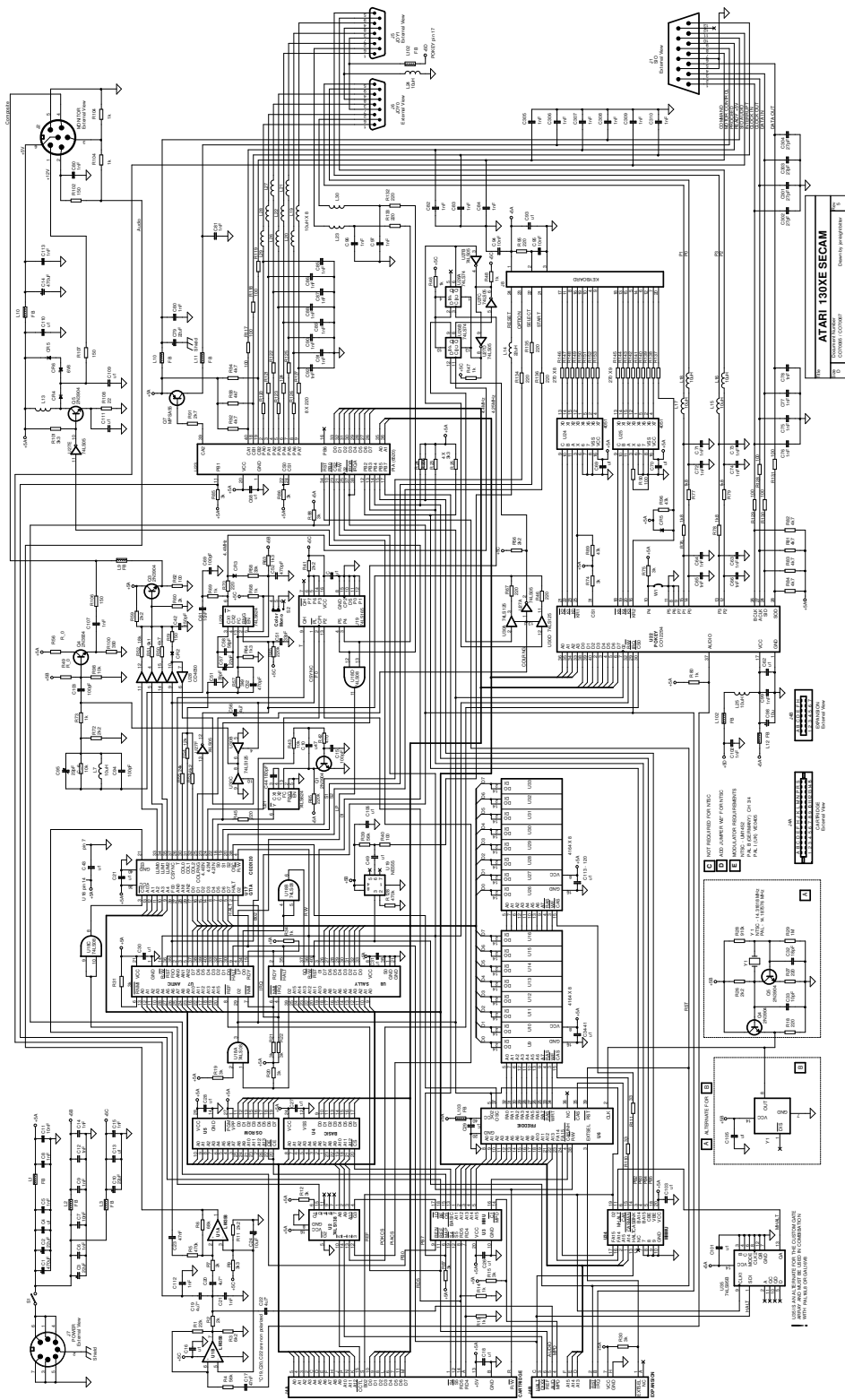

Figure 2-3. Schematic Atari 130XE SECAM CO70050

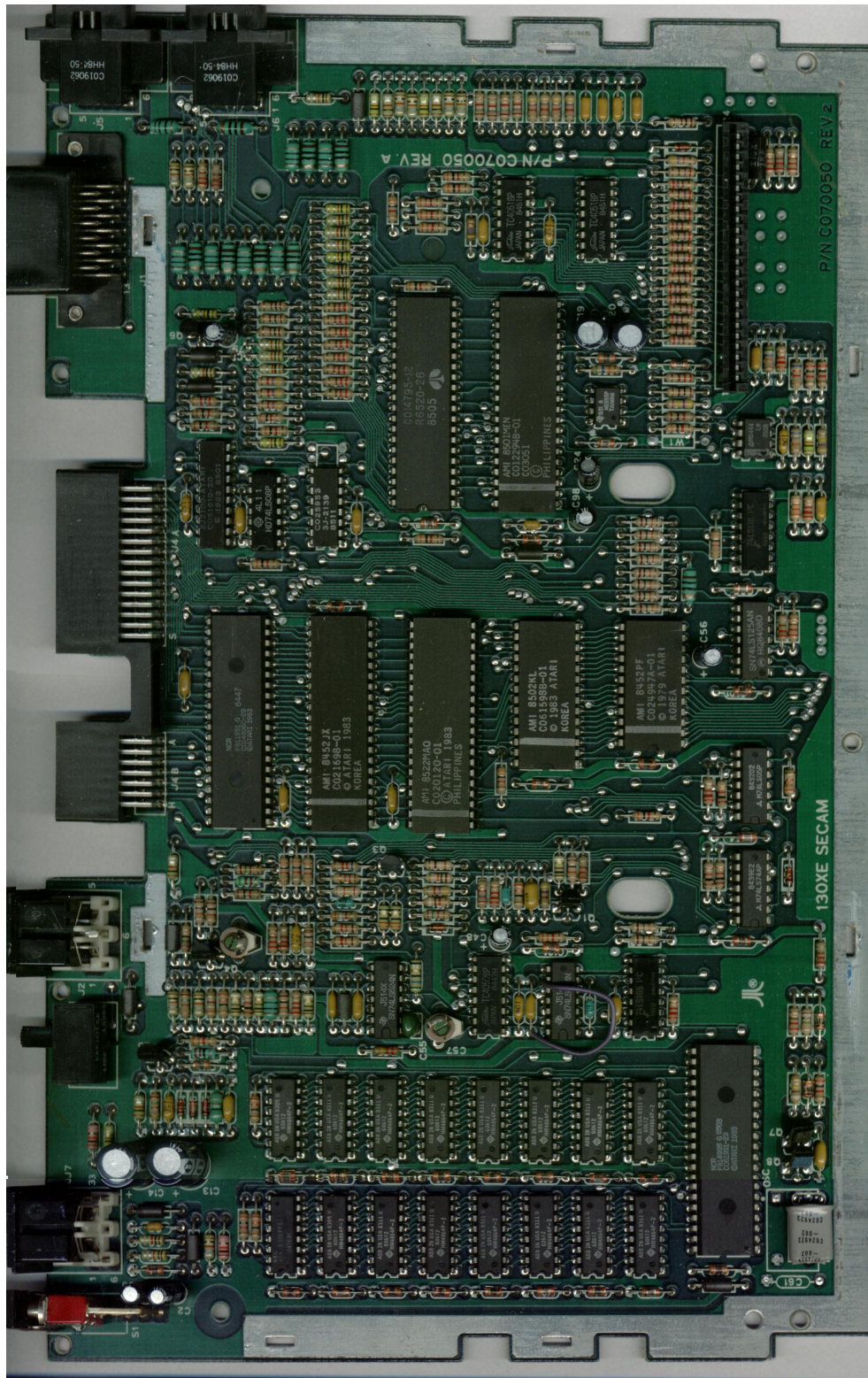

Figure 2-6. 130XE SECAM CO70050 Rev.2 PCB

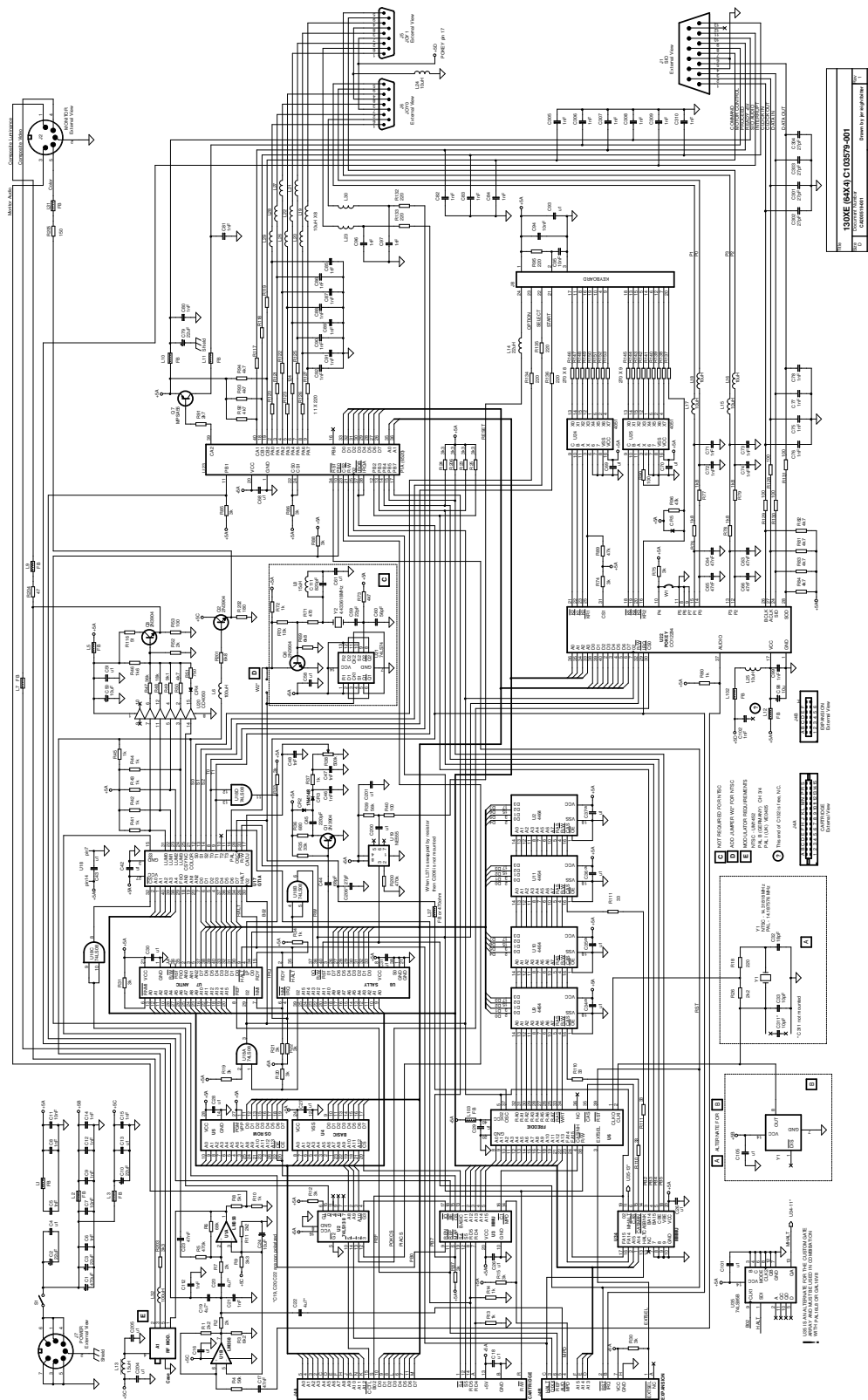

Figure 2-5. Atari 130XE 4 X 4464 Assembly CA200519



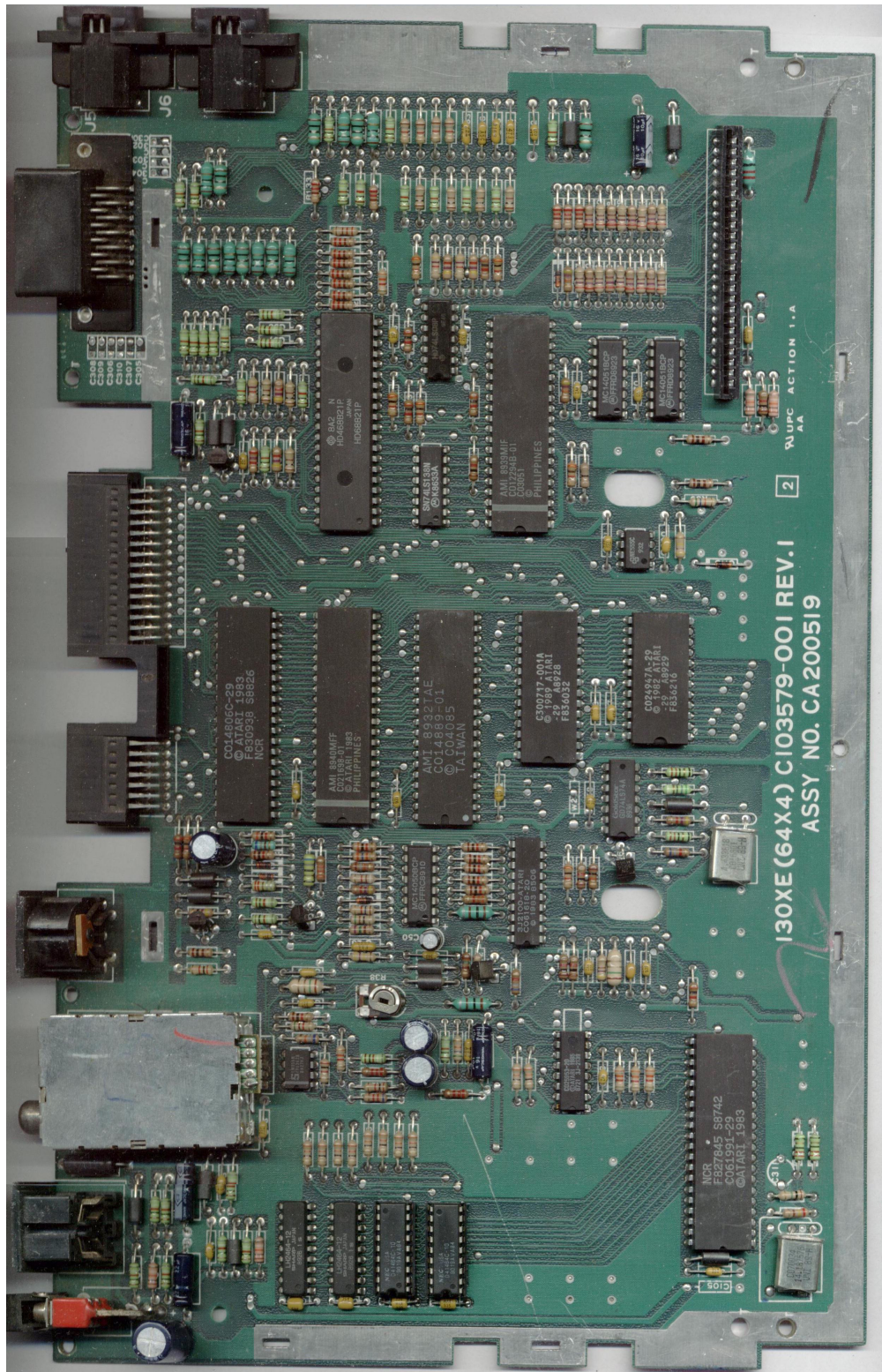

Figure 2-6. 130XE C103579/CA200519 PCB

130XE Personal Computer  
Field Service Manual

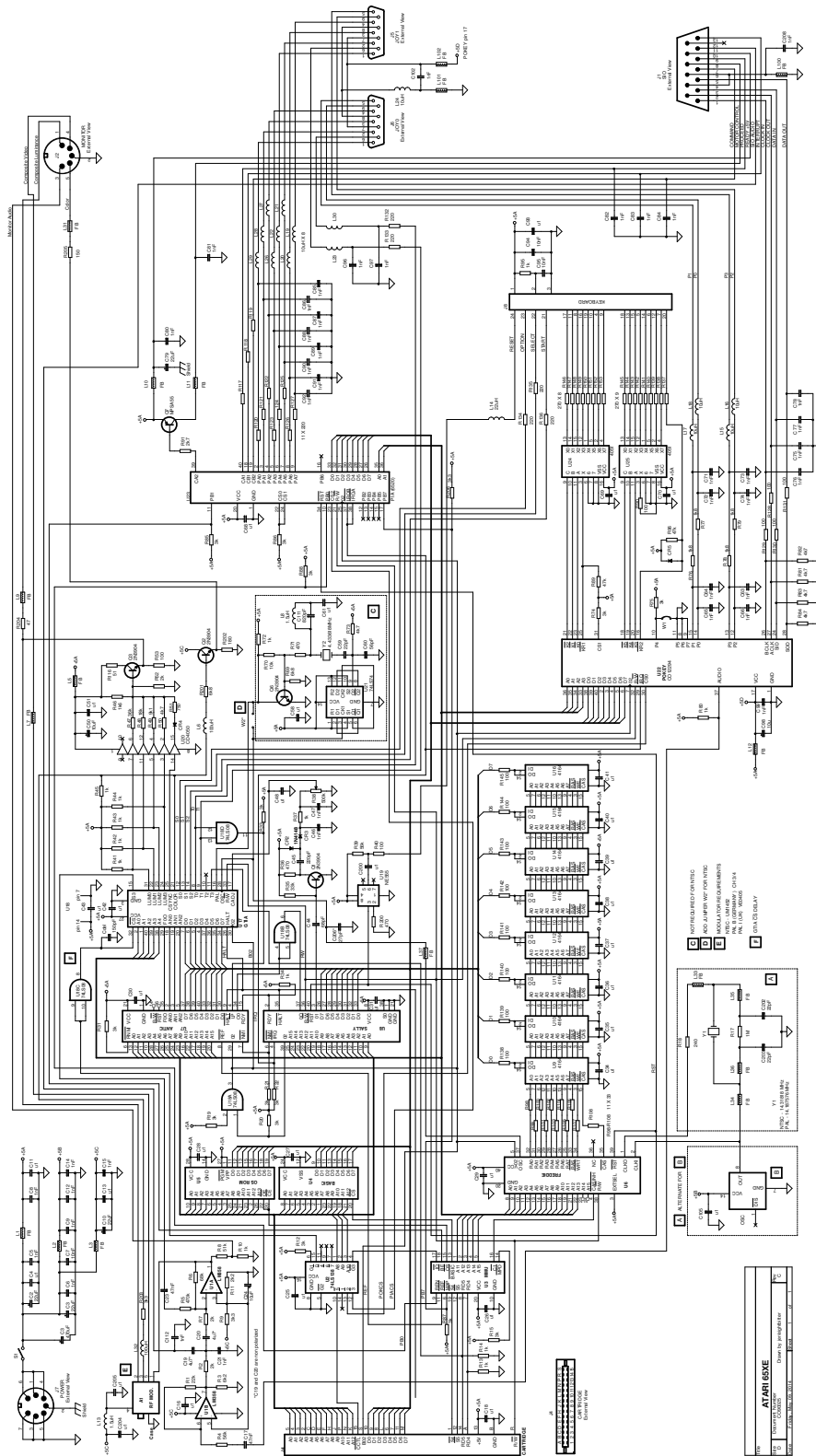

Figure 2-7. Atari 65XE 8 X 4164 Assembly CO70025

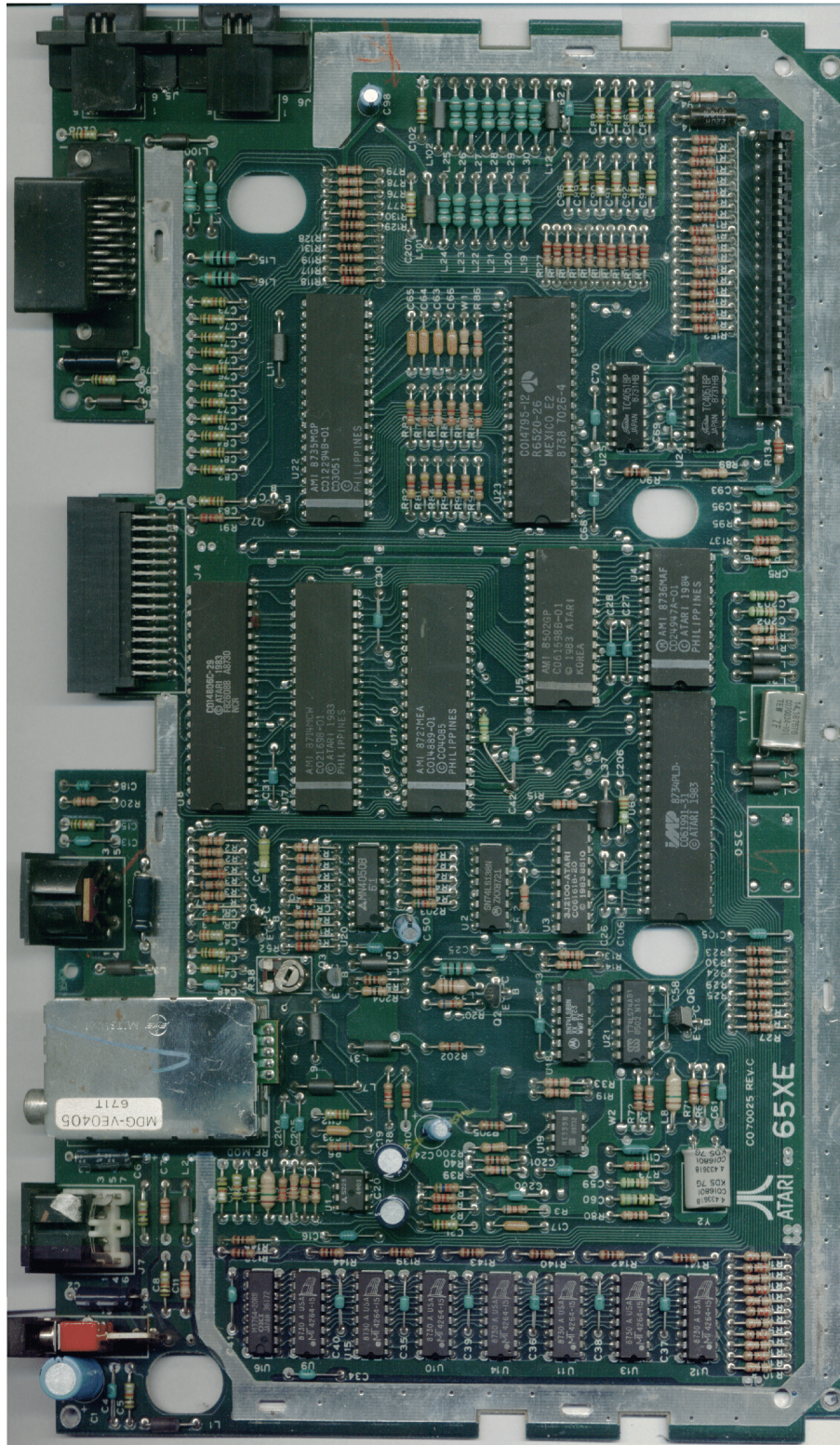

Figure 2-8. 65XE CO70025 PCB

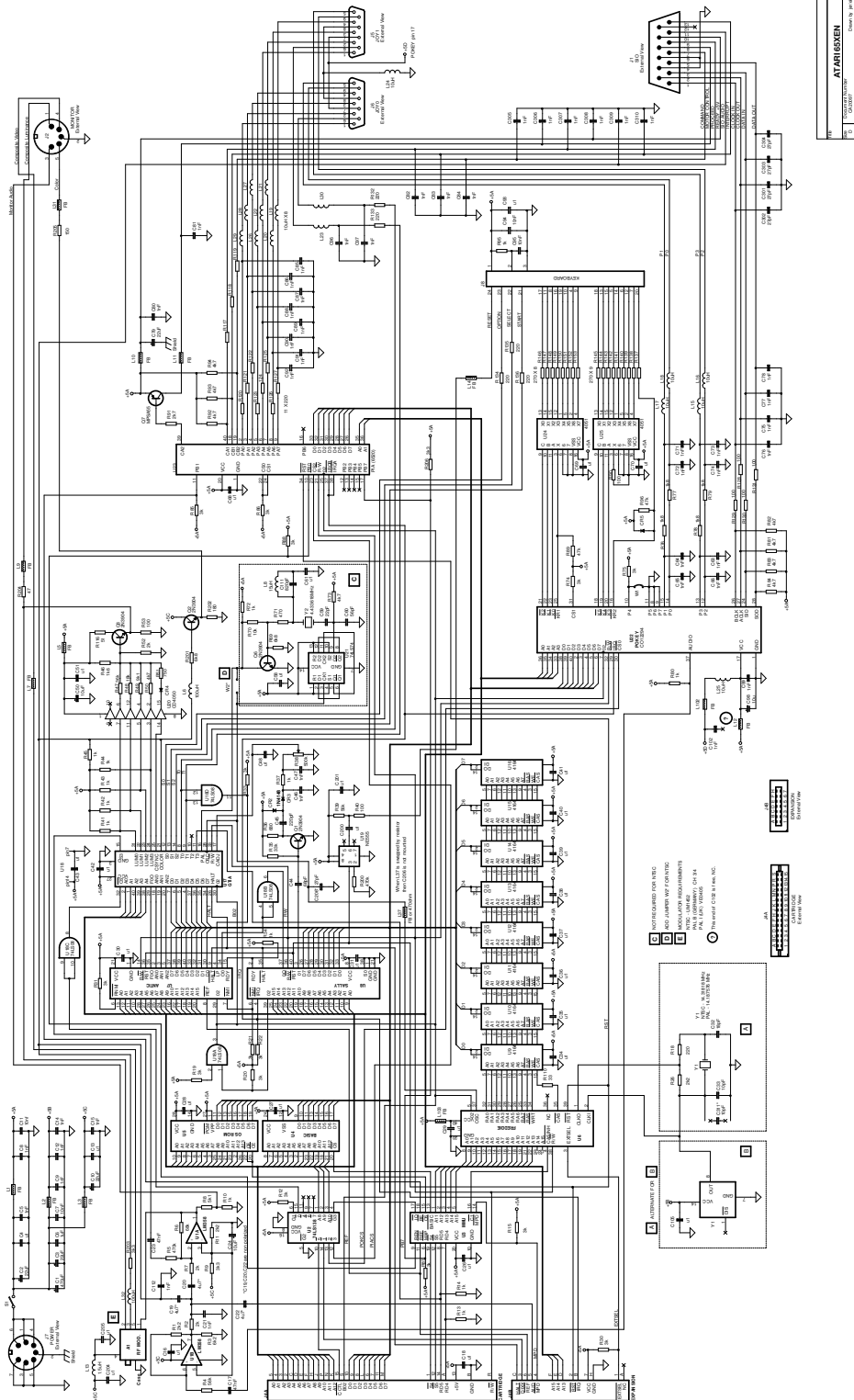

Figure 2-9. Atari 65XEN 8 X 4164 Assembly CA20097

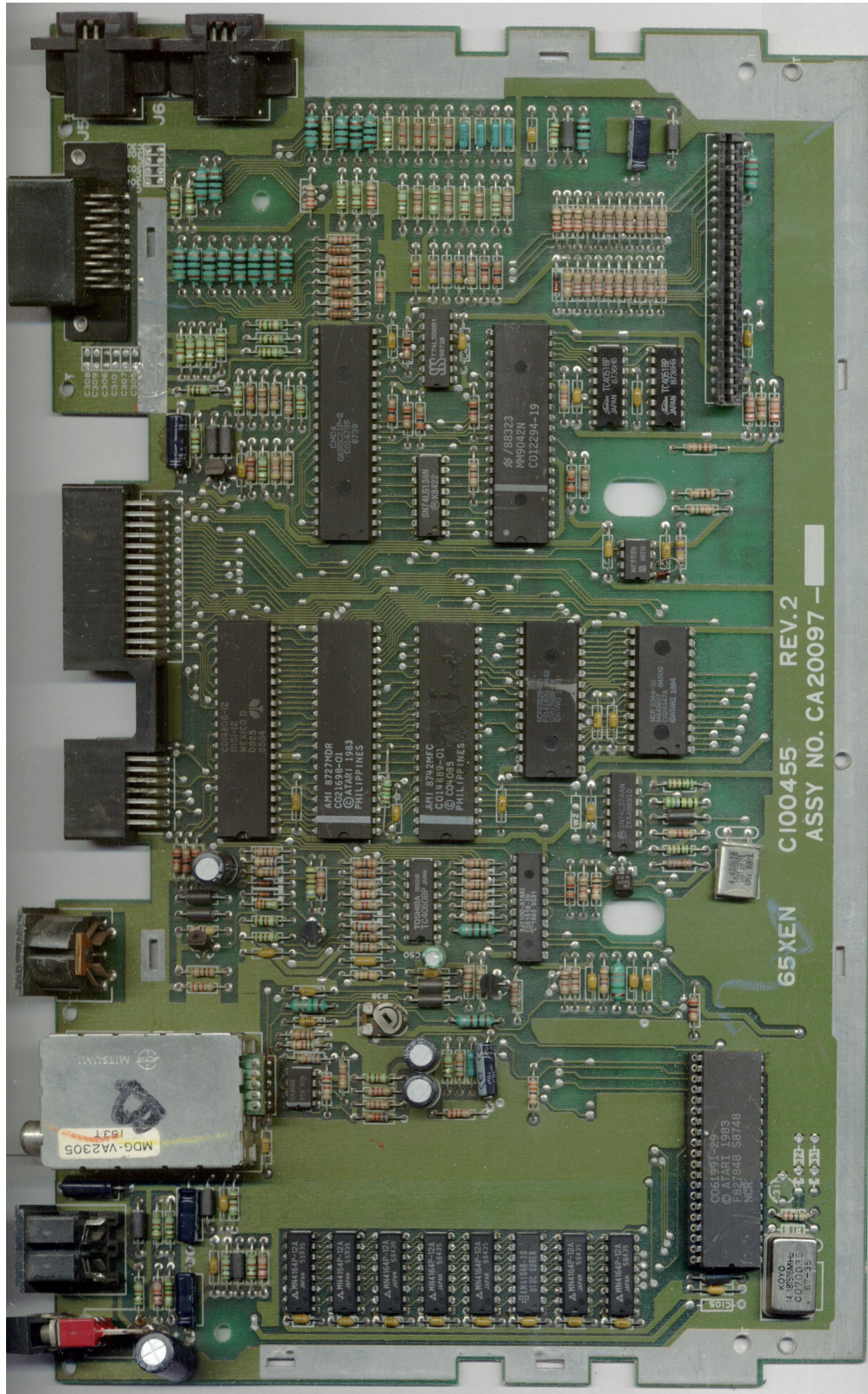

Figure 2-8. 65XEN CA20097 PCB

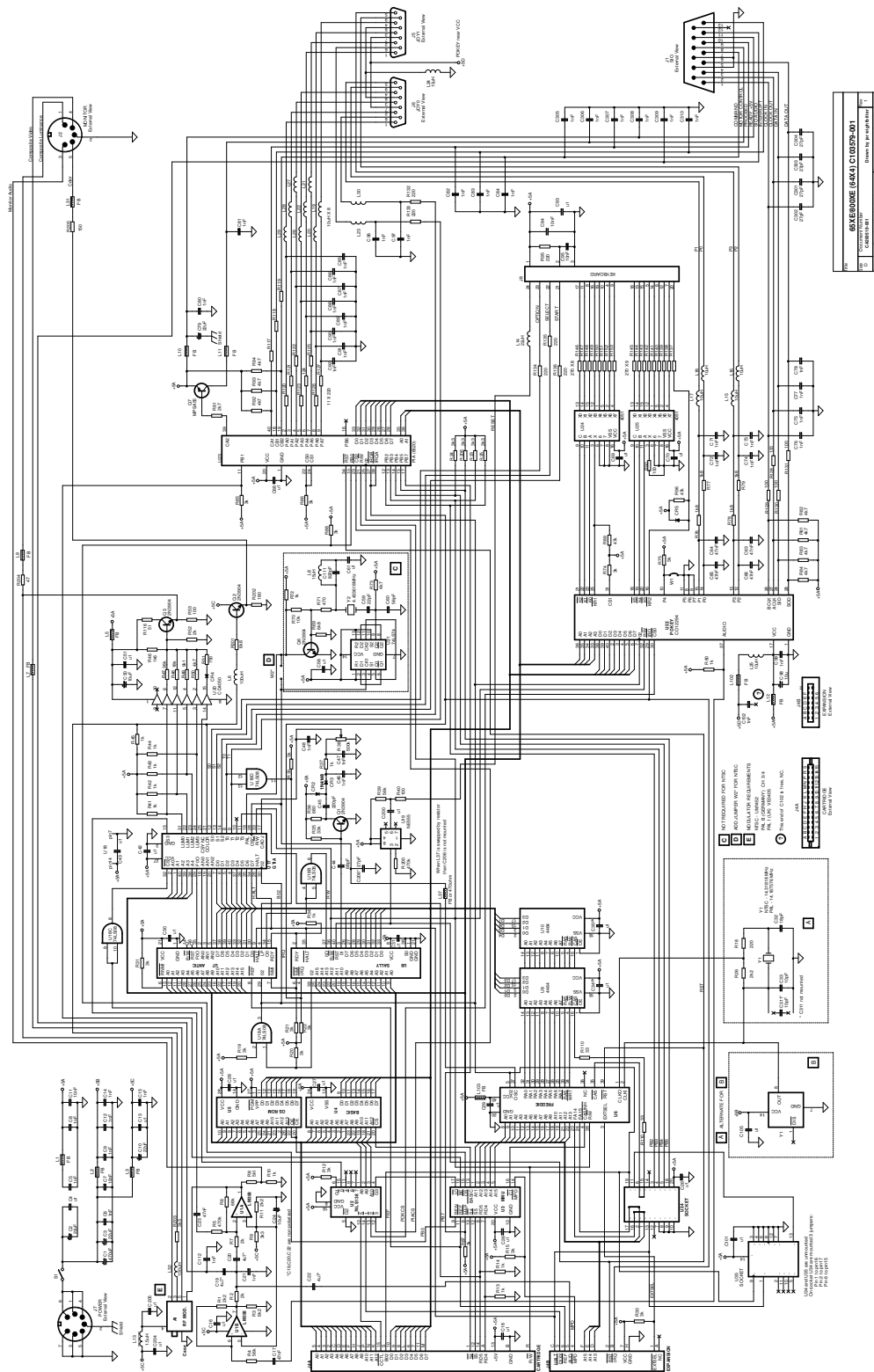

Figure 2-11. Schematic Atari 65XE/800XE 2 X 4464 Assembly CA200519

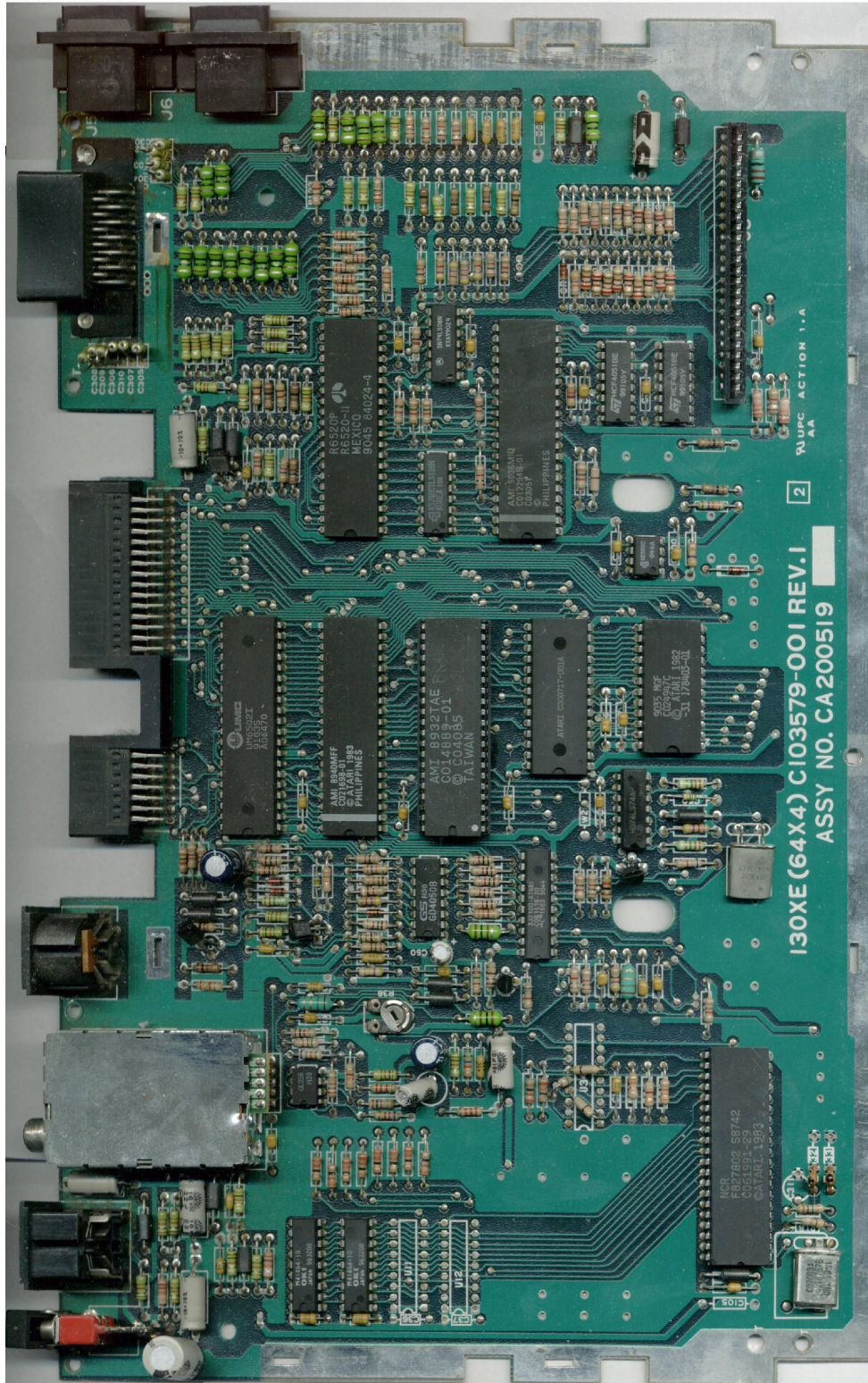

Figure 2-12. 65XE/800XE CA200519 PCB

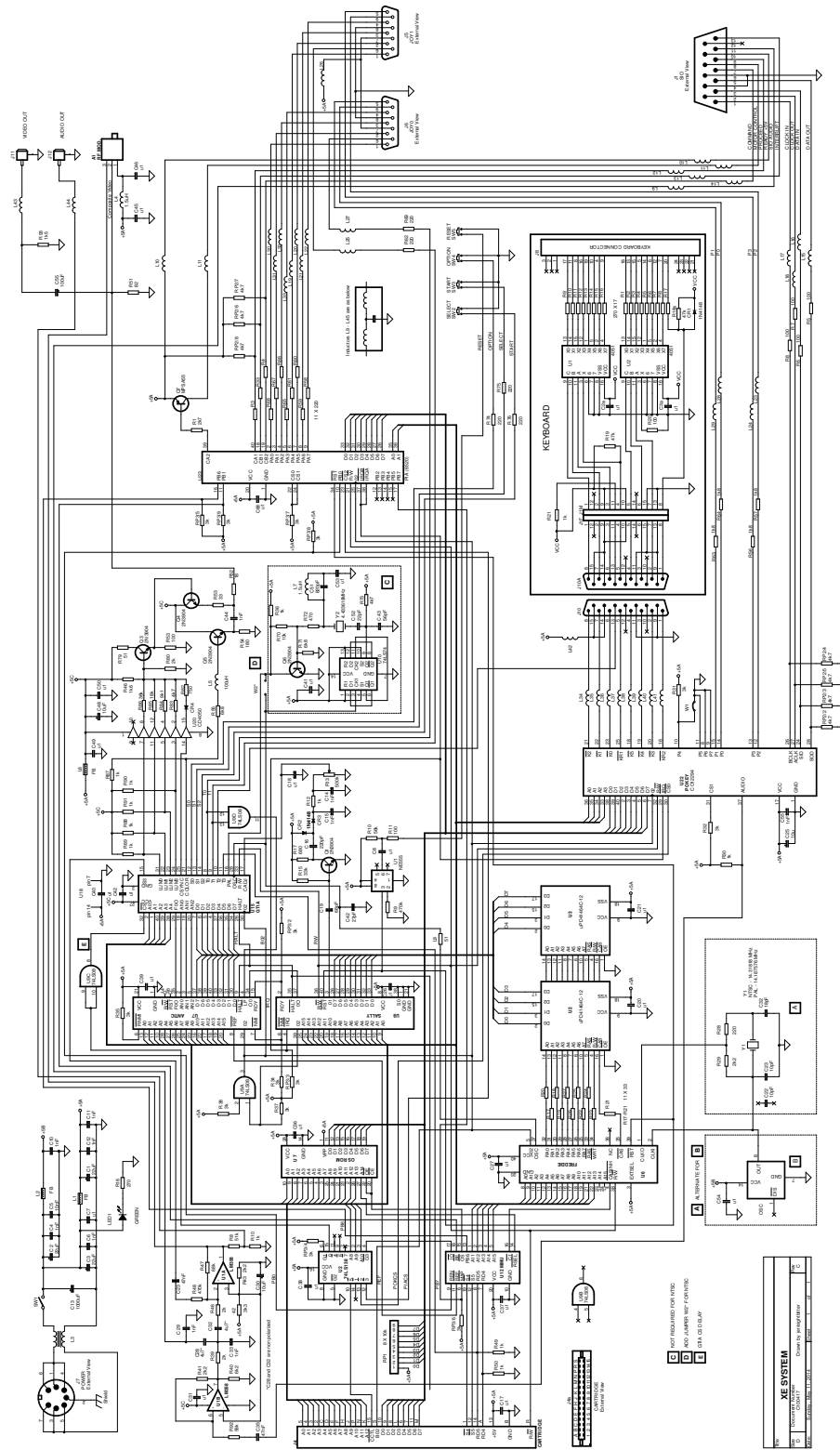

Figure 2-13. XE-System Assembly C100417



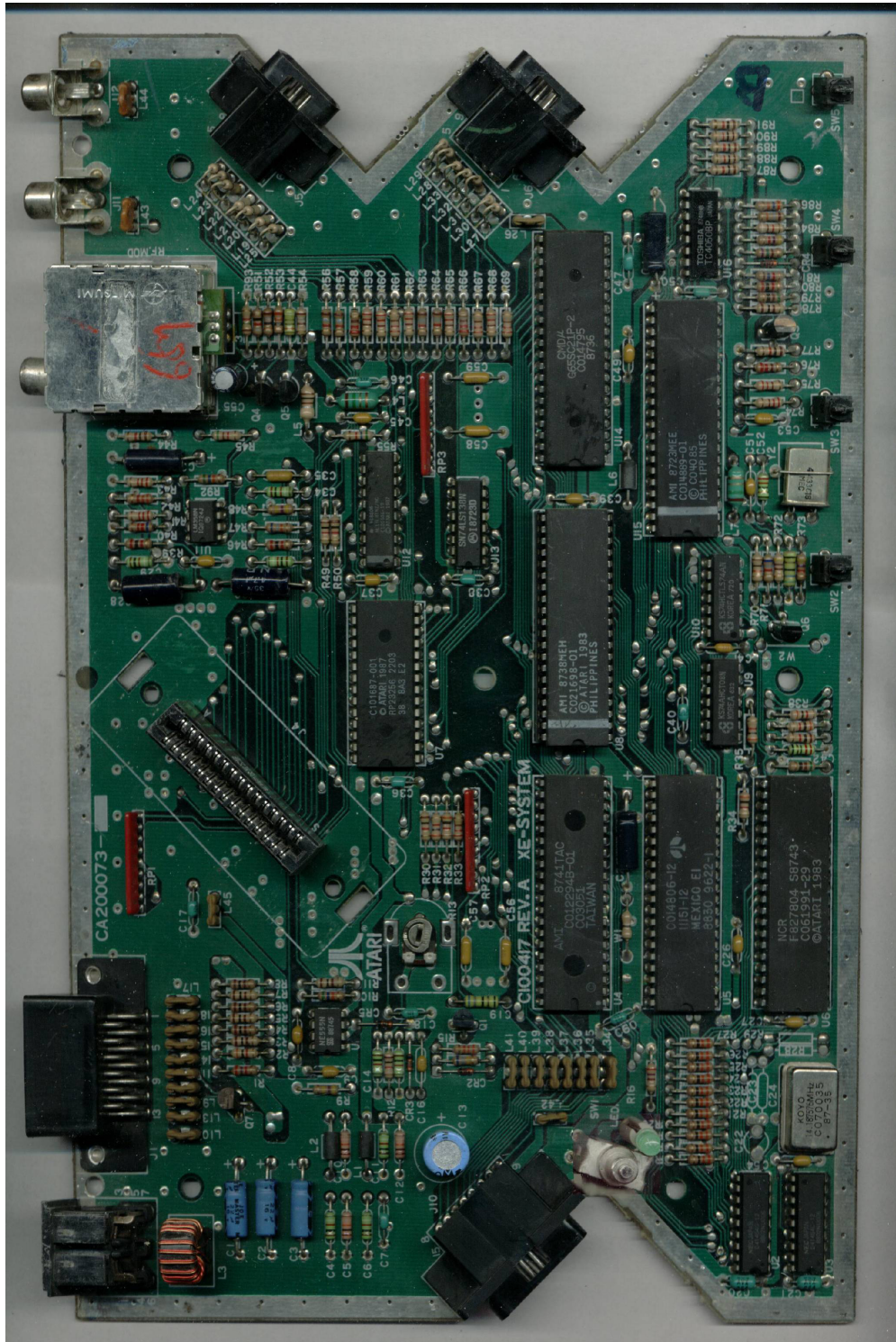

Figure 2-14. C100417 PCB



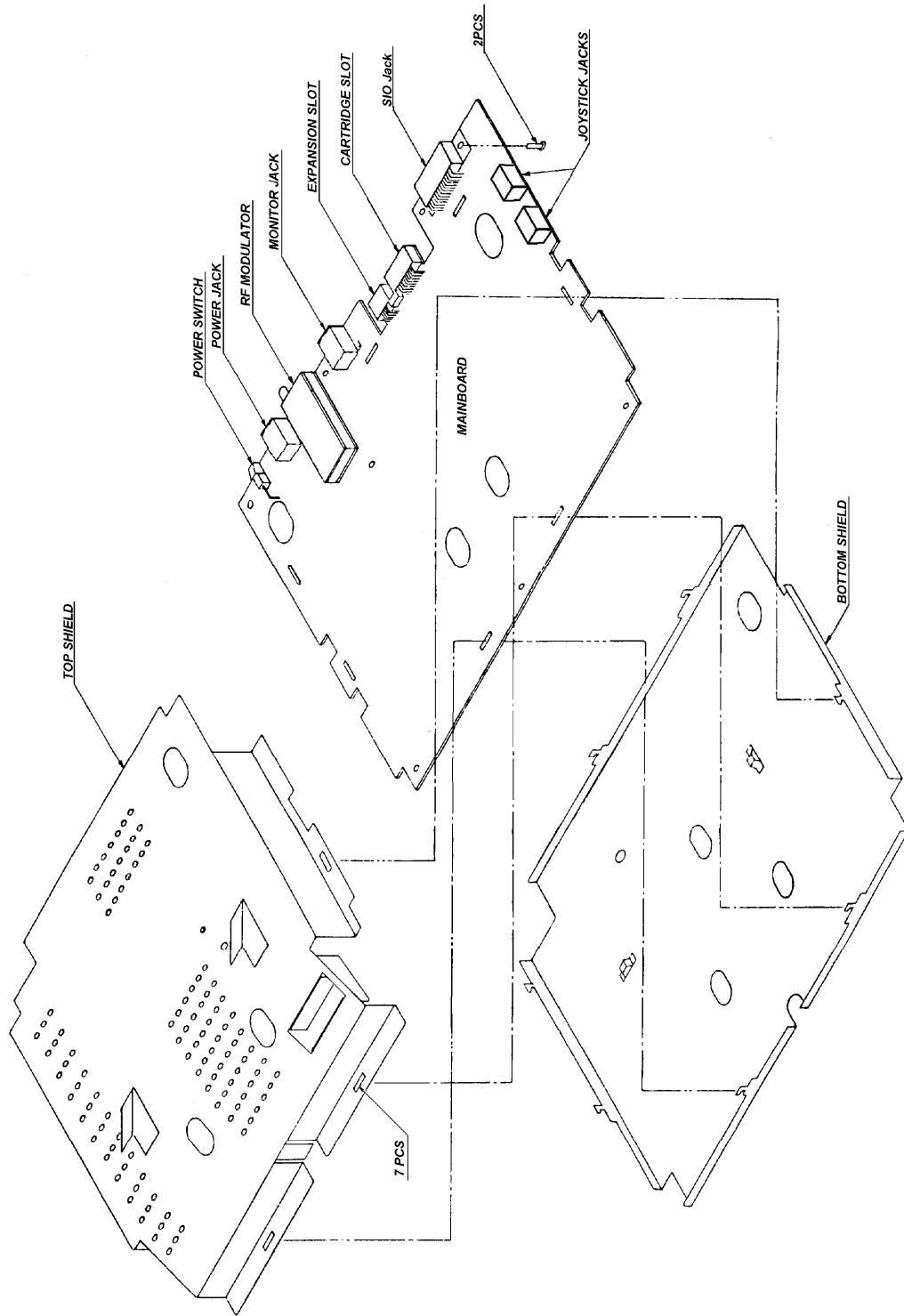

Figure 2-16. PCB and Shields Assembly

## SECTION 3

### TESTING

#### OVERVIEW

This section describes the procedures available for testing the 130XE. They are:

- Self Test
- Using Atari 65/130XE R.2 Diagnostic Cartridge

#### EQUIPMENT NEEDED

- a 130XE console with accessories
- a TV set, properly adjusted
- an Atari 65/130XE R.2 Diagnostic Cartridge with loopbacks

#### SELF TEST

The Self Test feature allows the user to perform minimal tests on the following components:

- Memory - RAM, ROM and ANTIC
- Audio/Visual - ANTIC, GTIA, and POKEY
- Keyboard - POKEY and ANTIC

To enter the testing sequence, press the HELP key while the power-on logo is on the screen.

NOTE: No cartridge should be inserted in the unit.

To exit the test, press the SYSTEM RESET key (causes the power-on initialization sequence) or the HELP key (exits back to the Self Test Screen Menu).

NOTE: Pressing the HELP key has no effect while the HELP (Self Test) screen is displayed.

#### Procedure:

1. Connect 130XE console to TV set as shown in owners manual.
2. Turn on computer and TV set.
3. Press HELP key when power-on logo appears.
4. The Self Test menu displays four options:
  - Memory
  - Audio Visual
  - Keyboard
  - All Tests



Figure 3-1. SELF TEST Menu

Press the SELECT key to move the selection down a line until you reach the desired test. Press the START key to begin the test.

**CAUTION:** Self Test will not go into Attract Mode. Do not leave the TV set on any of the SELF TEST screens for any length of time, since screen burning can occur.

#### MEMORY TEST SCREEN

Purpose: To test ROM, RAM and ANTIC chips.

Format: Two long bars display at the top of the screen. Below them are three rows with sixteen blocks representing the RAM (each block represents 1K). The two long bars displayed at the top of the screen represent the two 8K ROMs in the system. When either ROM or RAM is being tested, the corresponding bar segment color is white. If the ROM or RAM tests good, the bar color changes to light green. If the ROM or RAM tests defective, the color changes to red. Once a ROM or RAM has been tested and found defective the bar remains red and is not tested again on subsequent test passes.

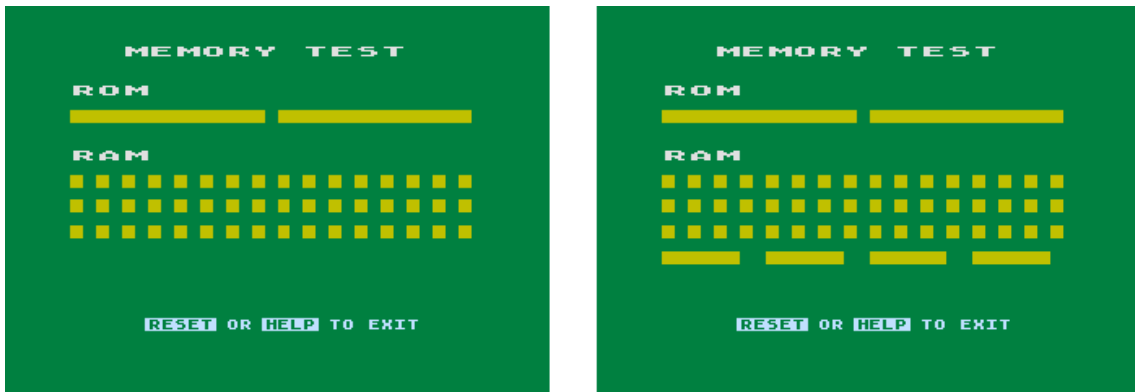

Figure 3-2. MEMORY TEST display (on left C061598, on right C300717)

On screens above are shown the results of the memory test for an older and a newer O.S. ROM. When on board is installed O.S. ROM C300717, then displays additional 4 bars showing the results of the test four 16K extended memory banks. The Memory Test loops and continues testing until either the HELP or RESET key is pressed.

1

#### AUDIO VISUAL TEST SCREEN

Purpose: To test the ANTIC and POKEY chips.

Format: This screen displays a music staff and treble clef. A sequence of six notes plays and the corresponding note shows on the staff. The tune plays sequentially from channel one through channel four. The channel number changes for each according to the sound channel in use. Voice #1-4 under the staff and treble clef indicates the channel in use. There is a slight pause between each voice.

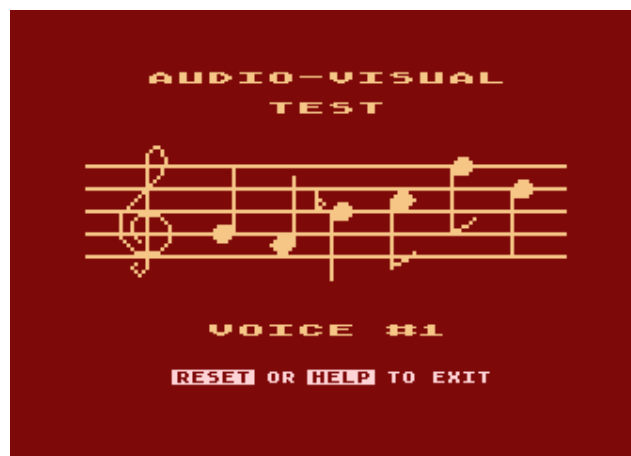

Figure 3-3. AUDIO-VISUAL Test display

The Audio Visual Test loops and continues testing until either the HELP or RESET key is pressed.

### KEYBOARD TEST SCREEN

Purpose: To test the POKEY, the ANTIC and ROM chips.

Format: A full keyboard displays. Press each keyboard key. The corresponding key on the screen should change to inverse video. It should change back to the original color when the key is released. NOTE: The control and shift keys change only when pressed at the same time as another key - the display for both keys will change to inverse video and then back. As each key (except RESET) is pressed, a tone is generated.

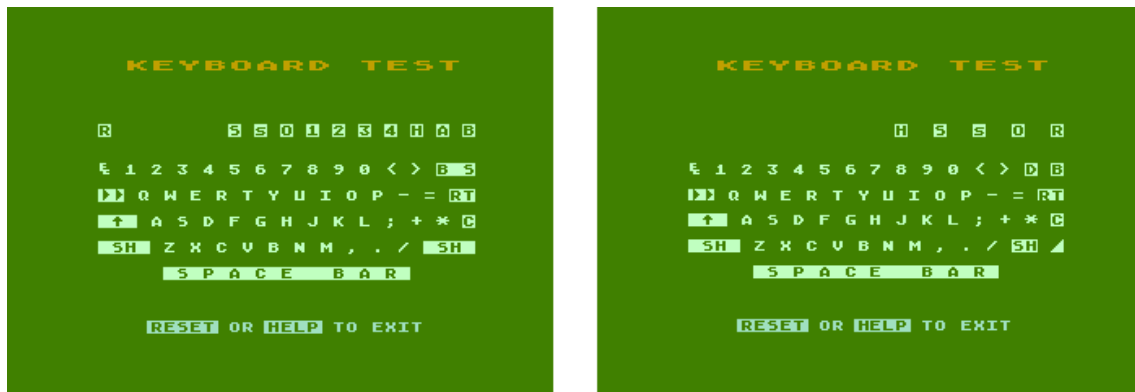

Figure 3-4. KEYBOARD TEST display (on left O.S.ROM v.1 & 2, on right v.3)

In O.S. ROM v.1 & 2 implemented Self Test 1200XL, hence the test are displayed keyboard function keys 1-4. In O.S. v.3 they do not exist.

NOTE: The BREAK key does not change appearance or generate a note when pressed.

### ALL TESTS

All of the Self Tests are continuously executed one after another until either the HELP or RESET key is pressed.

NOTE: When All Tests is executing, the MEMORY Test and the AUDIO-VISUAL Test exit after a complete test cycle.

KEYBOARD Test during All Tests is software controlled. No operator input is required.

## USING THE ATARI 65/130XE REV. 3.4 TEST CARTRIDGE

### Procedure:

Connect the 130XE console to the TV set as shown in the Operators Manual.

Insert the ATARI 65/130XE R.2 Test Cartridge in the cartridge slot and Test Loopbacks into proper jacks.

Turn on the computer and TV set.

After a few seconds Select Screen displays. (See Figure 3-1).

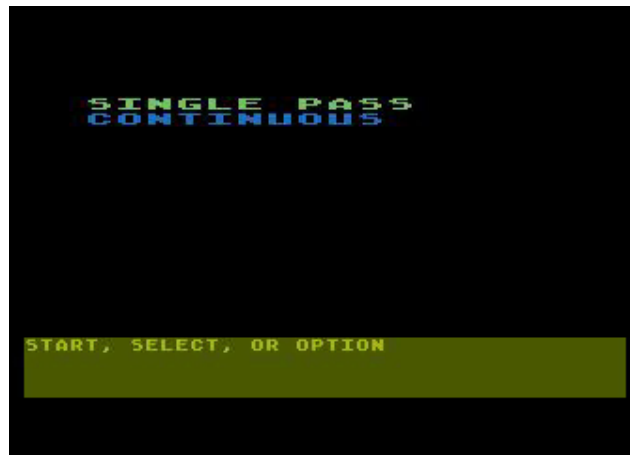

Figure 3-5. Select display

Press SELECT key to select testing mode. CONTINUOUS test allows the execution of the selected in next step test in the loop multiple, SINGLE PASS performs selected test one time. After selecting testing mode press START, then displays Main Menu (see below).



Figure 3-6. Main Menu display(on left 65XE NTSC, on right 130XE PAL)

130XE Personal Computer  
Field Service Manual

3-4

Now you can choose the right test.



PRODUCTION TEST - tests performed then in turn, the transition to the next requires pressing the any key, i.e. space bar. Please follow the instructions on the green box at the bottom of the screen.

AUDIO tests Pokey sound channels (see below).

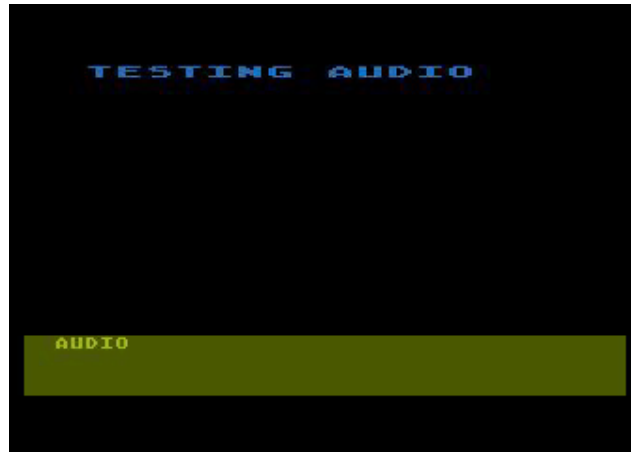

Figure 3-7. AUDIO Test Screen

Audio Test listen for 6 pure tones, followed by a noise “buzz”. Adjust TV or Monitor volume if necessary. If a tone is missing or the sound is bad, make note of it. The test is repeat until space bar is pressed. The 6 tones are produced by POKEY chip. The buzz is produced by GTIA.

#### VIDEO

1. The display has 3 parts (see Fig. 3-8 Video Test display). The top half of the screen shows the 9 color registers representing the players, missiles, and playfields against a gray background. The middle of the screen shows 4 players and 4 missiles (one color) moving up and down 1 scan line. The bottom of the screen shows a color tuning bar.

The operator must verify that:

- Each of the 12 players, missiles, and playfields is distinct (separated by gray background).
- 8 luminance levels (black to white) are shown.
- All colors are present and uniform across the screen.
- The players and missiles in the middle of the screen move up and down.
- The color tuning bar is one solid color. If the color is out of adjustment, another color bar will show inside the tuning bar. Adjust the trim pot until this smaller bar disappears (can be reached from hole in housing bottom). It will be noted that the colors do not exactly align horizontally. This is acceptable. The operator should reject machines with problems such as:
  - Missing/overlapping players, missiles or playfields.
  - Flecks of (wrong) color at the margin of players, missiles or playfields.
  - Gaps in the luminance or color bands (except the 5th gray bar and 1st color bar, which are the same as the background color).

These problems likely indicate a bad GTIA chip.

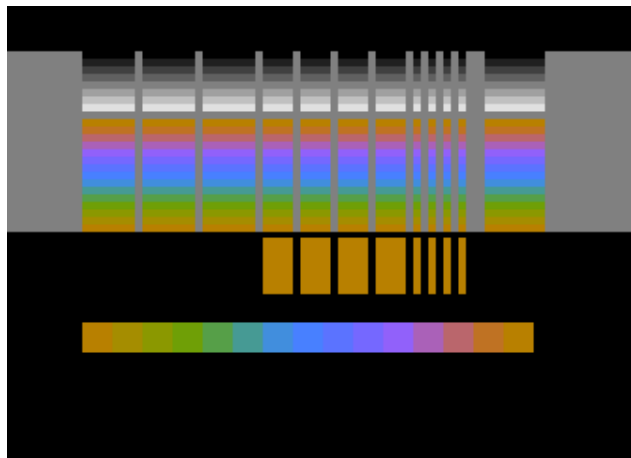

Figure 3-8. VIDEO Test display

#### PORT

The top of the screen will go blank until the test is completed. PASS or FAIL will be printed. If the test fails, one or more error codes will be displayed. Make note of the error code and press the space bar to continue with the next test.

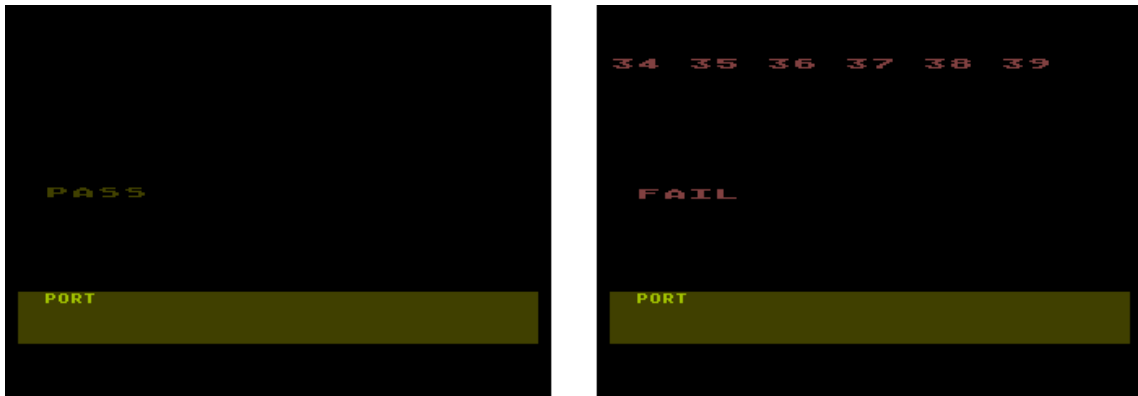

Figure 3-9. PORT Test display

In figure above PORT test results are shown: left – ports OK, the right errors due to lack of loopbacks.

#### DIAGNOSTIC ERROR CODES

During the test, using a test cartridge can occur error codes (for a bright background word ERROR CODE XX). In some cases, usually when damaged RAM area of the screen, the word may be wrong, reversed, etc.

The meaning of the error codes described below.

#### SYSTEM ERRORS

- 01 ANTC's horizontal or vertical sync error.
- 02 ANTC's vertical blanking interrupt error.
- 03 DISPLAY LIST interrupt error.
- 04 Writing or reading page 0 or 1 RAM error.
- 05 Data lines error. Possible damage RAM.
- 06 Address lines or address decoding error (damage RAM).
- 07 Refresh when saving byte 00 error.
- 08 Refresh when saving byte FF error.
- 10 Writing status register errors. Damage RAM
- 11 An error was detected during the test POKEY-timers.
- 12 POKEY interrupts error

#### ERRORS PORTS

- 34 Serial communication fault. Damage to the line DATA IN or DATA OUT or damaged POKEY.
- 35 Control serial communication error. Faulty line PROCEED, INTERRUPT or COMMAND. Faulty PIA or POKEY.
- 36 Control serial communication error. In any case of error 35 can also occur when an error 36 error 35 can not occur - POKEY damaged or IRQ line to the processor or the processor itself.
- 37 Joystick port error. Socket is damaged, the lines connecting them to the PIA or PIA.
- 38 Damage to potentiometric inputs. Damaged socket, connecting lines or POKEY.

39 Malfunction FIRE button. Socket connecting lines or GTIA damaged.

34-39 Errors may occur in poor contact pin control (loop-back) or being damaged.

### KEYBOARD

12 keys are displayed on the screen. As each of these keys is pressed, the key on the screen should change color. The last key to be pressed must be the OPTION key. After the option key is pressed, the test is over. If all keys were detected, the next test will begin. If not, the screen will turn red. To reset the test, push START, or to continue with the next test, push SELECT.



Figure 3-10. KEYBOARD Test display

### ROM TEST

The screen will display PASS or FAIL when done. Press the space bar to begin the next test.

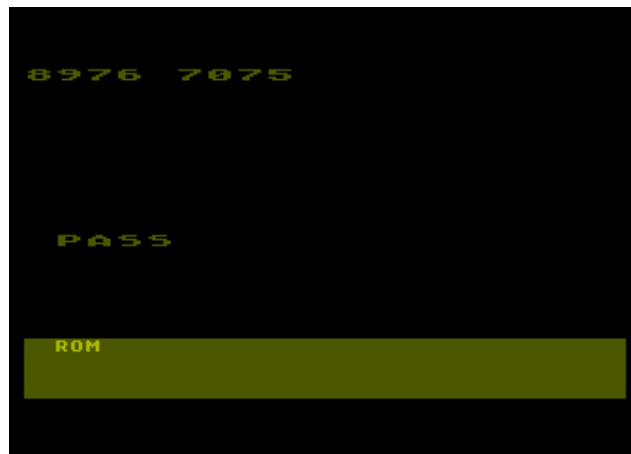

Figure 3-11. ROM Test display

## RAM TEST

If no errors occur, the test will take about 15 seconds. When the test is done, PASS or FAIL will be displayed. Press the space bar to continue.



Figure 3-12. RAM Test 65XE OK.

If an error does occur, the test will halt, and the test number (1-4), the address which failed, the data read from that address, the data expected, and the bits that failed (i.e. numbers 1-8, corresponding to 8 ram chips, printed red if data was bad, green if good) will be displayed to the screen, as in the following example:

```
1 (test number)
7E45=34 35 (address, data read, data expected)
1 2 3 4 5 6 7 8 (bit numbers)
```

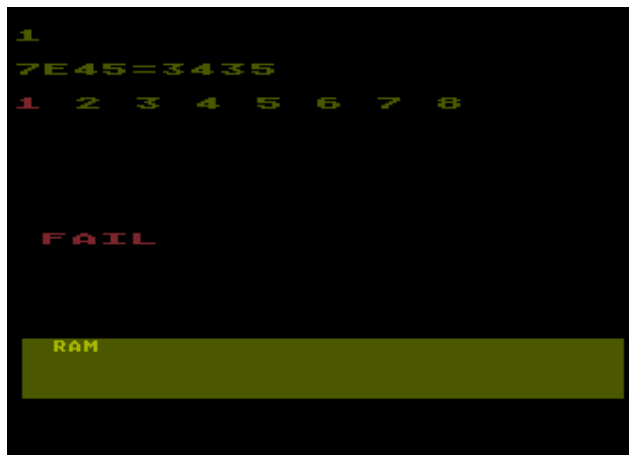

Figure 3-13. RAM Test Fail

On completion of all tests, the screen will show any tests which failed (except AUDIO or VIDEO, since the operator must determine if the test passes). Finally, the operator should press the reset key to verify that it works (the screen should go blank).

### FOR 130XE ONLY CARTRIDGE & EXPANSION SLOT TEST FIXTURE

The CARTRIDGE & EXPANSION SLOT test fixture (Fig. 3-9) insures that all traces are properly connected on the PCB. On power-up of the computer the board looks for a state change on all output and bidirectional lines. If NO state change is detected then the corresponding LED will light.

In order to test the input lines the operator will have to select PBI test from the menu. Once selected it will report 3 types of errors:

1. ERROR 71; This means that either RD4 or S4 is not present on cart connector and/or A13 is not present on Expansion connector.
2. ERROR 72; This means that MPD is not present on Expansion connector.
3. ERROR 73; This means that EXSEL is not present on Expansion connector.

The Audio In line is also tested by the software, when you select PBI a motor type noise should be heard from the TV or Monitor speaker. If NO noise is heard then Audio In is not present on Expansion connector.

If Errors 72,73, and no sound occur simultaneously then CCTL line on cart connector is not present.

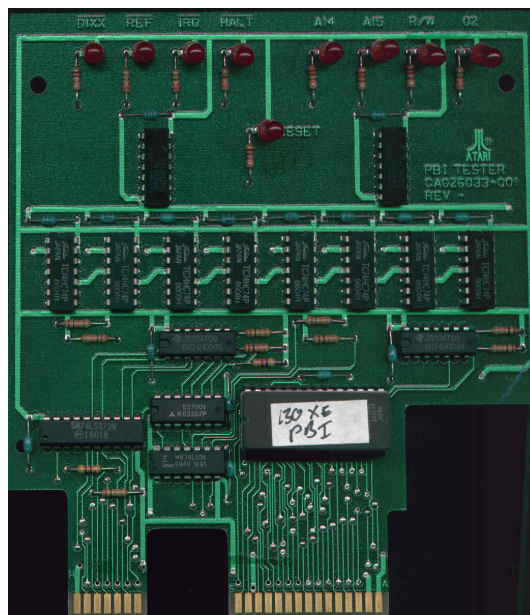

Figure 3-14. Cartridge & Expansion Slot Test Fixture

**SECTION 4**  
**SYMPTOM CHECKLIST**

The Symptom Checklist is designed to assist you arrive at a rapid diagnosis for problems. Each symptom is accompanied by some possible causes. Instructions for Disassembly/Assembly, adjustments and/or replacements are on the pages following this Symptom Checklist.

SYMPTOM	POSSIBLE CAUSES	REMEDY
Snowy Screen	Switch Box, Power Supply, Channel Select Switch, RF Modulator or Cable Damage	Adjust or replace (See Page 4-4)
Black/Gray Screen	+5VDC, L4-L8, ANTIC, CR8, Power Plug, SW1, Y1	Replace
Green/Yellow Screen	U27, U1-U9, U12, U13	Replace
Solid Blue Screen	U24, Q3, Y1, Q2, Q4, U19	Replace
No Color or Bad Color Bars	VR1 Adjust, U20, U2, U19, Q3, Y1, RF Modulator	Adjust or replace (VR1 Adjust – Page4-2; RF Modulator Adjust Page 4-4)
No Color Bars on TIA test	U19	Replace
No Lights (L1, L2, L3)	LED 3, LED Pin 1, +5A Power Supply, U23, Q9 Q10, Pin 3, Pin 4	Replace. If problem is LED – replace the LED Board
No Gray Bars	RF Modulator, Y1, VR1, Q3, U19	Adjust or replace (VR1 Adjust – Page4-2; RF Modulator Adjust Page 4-4)
Upside down Alphanumerics or Player Field	U20, U19, U3	Replace
Some Keyboard Keys Fail	U24, Keyboard	Replace (See Page 4-4)
All Keyboard Key Fail	U24, Keyboard	Replace (See Page 4-4)
Tones Missing During Sound or Games	U24, L11, L12	Adjust or Replace (Adjust Audio Figure 4-1)
Console (Game) Switches will not Function	U19, U23	Replace
ROM Test Failed	U12, U13, U14, U18, U22	Replace
RAM Test Failed	U1-U9, U7, U14, U22	Replace

## ADJUSTMENTS AND REPLACEMENTS

### CONSOLE DISASSEMBLY

1. Turn console upside down and place on the workbench.
2. Remove the four screws that hold the bottom cover to the top cover.
3. Turn it right side up and remove the top cover .
4. Carefully disconnect keyboard and remove it.
5. Remove the seven screws that hold the shielded PCB in place.
6. Remove the shielded PCB from the bottom cover.
7. Unbend the tabs of shielding (7 tabs).
8. Separate the top and bottom RF Shields . Take care that PCB is not damaged.

### CONSOLE ASSEMBLY

1. Position the bottom shield on the bench and align the tabs.
2. Position the PCB on the bottom shield, looking to proper inserting of all tabs to elongated holes on PCB.
3. Position top shield of PCB, looking to proper inserting of all tabs to elongated holes of top shield. Be sure that adjustment holes are clear.
4. Bend all tabs to proper fix shields on PCB.
5. Place bottom cover with right side up on bench.
6. Insert PCB/shields assembly to bottom cover and position it. Be sure that screw holes are aligned and make sure that fixing stakes are proper inserted in the holes of PCB.
7. Attach with seven screws.
8. Carefully connect keyboard and position it in keepers of bottom cover.
9. Insert and position top cover on bottom assembly.
10. Hold the assembly together, turn console upside down and attach four screws.



## KEYBOARD REMOVAL/REPLACEMENT

1. Remove the top cover from the console.
2. Remove the keyboard connector and LED connector. Note the position of the LED connector for reference during assembly.
3. Remove the four screws which hold the keyboard to the top cover. 4. Remove the keyboard from the top cover.

### TO REPLACE THE KEYBOARD

1. Place the top cover upside down on the workbench.
2. Install and position the new keyboard.
3. Insert and tighten the four screws which hold the keyboard to the top cover.
4. Attach the keyboard connector and the LED connector (Be careful not to twist the LED connector cable).

### COLOR ADJUSTMENT

Adjustment can be made through bottom cover.

## SECTION 5

### SERVICE BULLETINS

This section is to be used by you to file the three classifications of service bulletins which are periodically released by the Manager of Technical Support.

The following are brief descriptions of each classification:

#### FIELD CHANGE ORDER

A Field Change Order describes hardware or software changes to ATARI products and instructs how to implement these changes. This identifies a failure mode which affects reliability and describes a procedure to correct the failure. This procedure must be performed on all units serviced or repaired.

#### UPGRADE BULLETIN

An Upgrade Bulletin describes product improvements or modifications which the consumer may wish to purchase. These Bulletins allow you to modify the customer's unit to add capabilities which may not have been available when the unit was originally manufactured.

#### TECH TIP

A Tech Tip is a document of a general nature which transmits routine service or repair information. By communicating methods developed since you attended training classes, Tech Tips aid to continuously improve repair skills and increase knowledge of ATARI Products. Other times, Tech Tips alert you to units which have been modified and are now standard from ATARI Manufacturing, but are different from many existing units and require different repair techniques.